

# VEDA IN DRIVES

## Manual for RD30 frequency converters

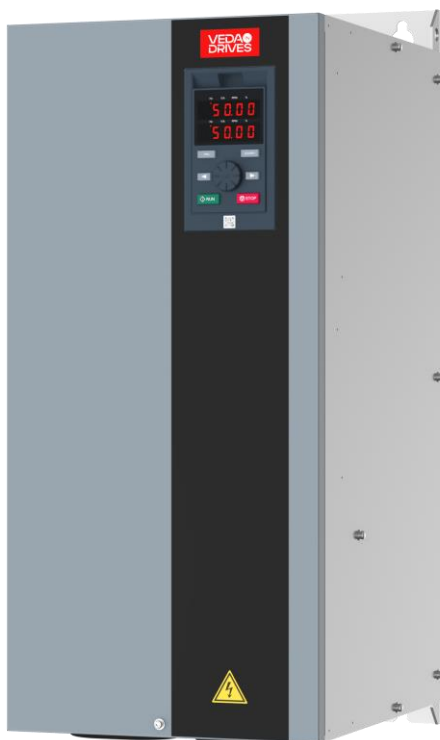

# Contents

<b>1</b>	<b>OVERVIEW.....</b>	<b>1</b>
1.1	SAFETY PRECAUTIONS .....	1
1.2	BEFORE USE .....	1
1.3	TECHNICAL SPECIFICATIONS .....	3
<b>2</b>	<b>INSTALLATION .....</b>	<b>4</b>
<b>3</b>	<b>KEYBOARD LAYOUT AND OPERATING INSTRUCTIONS.....</b>	<b>10</b>
<b>4</b>	<b>FUNCTION PARAMETER TABLE .....</b>	<b>12</b>
4.1	PARAMETER ICON DESCRIPTION .....	12
4.2	PARAMETER CONTENT .....	12
4.3	ENVIRONMENT APPLICATION .....	13
4.4	F01: BASIC SETTINGS.....	13
4.5	F02: MOTOR PARAMETER.....	16
4.6	F03: VECTOR CONTROLLING .....	18
4.7	F04 : V/F CONTROLLING .....	21
4.8	F05: INPUT TERMINAL .....	22
4.9	F06: OUTPUT TERMINAL .....	26
4.10	F07 : OPERATIONAL CONTROL .....	29
4.11	F08: AUXILIARY CONTROL .....	31
4.12	F09: RESERVED.....	32
4.13	F10: PROTECTION PARAMETER.....	32
4.14	F11: OPERATOR PARAMETER.....	35
4.15	F12: COMMUNICATION PARAMETER .....	37
4.16	F13: PROCESS PID CONTROL .....	39
4.17	F14: MULTI-SPEED AND SIMPLE PLC.....	41
4.18	C0x: MONITORING PARAMETER.....	44
4.19	TERMINAL SELECTION FUNCTION .....	45
4.20	FAULT AND WARNING CODE TABLE .....	46

<b>5</b>	<b>INSPECTION, MAINTENANCE AND GUARANTEE</b> .....	<b>48</b>
5.1	INSPECTION.....	48
5.2	MAINTENANCE.....	49
5.3	PRODUCT WARRANTY.....	49
	<b>APPENDIX I: MODBUS COMMUNICATION PROTOCOL</b> .....	<b>50</b>
	•COMMUNICATION FRAME STRUCTURE .....	50
	•COMMAND CODE AND COMMUNICATION DATA DESCRIPTION.....	50
	<b>APPENDIX II: TERMINAL WIRING METHOD</b> .....	<b>53</b>



# 1 Overview

## 1.1 Safety Precautions

To ensure safe and reasonable use of this product, please use the product after fully understanding the safety precautions described in this manual.

### Warning signs and meanings

The following symbols are used in this manual to indicate that it is an important part of safety. Failure to follow these precautions may result in personal injury or death, damage to this product and associated systems.

 <span style="margin-left: 10px;">Danger</span>	<p><b>DANGER:</b> Death or major safety hazard can result from incorrect operation.</p>
 <span style="margin-left: 10px;">Caution</span>	<p><b>Caution:</b> Wrong operation may cause minor injuries</p>

### Operational qualification

This product must be operated by trained professionals. Moreover, the operator must be trained in professional skills, familiar with the installation, wiring, operation and maintenance of the equipment, and properly respond to various emergencies in use.

### Safety guidance

Warning signs are provided for your safety. They are measures to prevent injury to the operator and damage to the product and associated systems. Please read this manual carefully before use and follow the safety rules and warnings in this manual strictly while operating.

- Proper transportation, storage, installation, and careful operation and maintenance are essential for the safe operation of the inverter. During transmission and storage, ensure that the inverter is not subject to shock and vibration. It must also be stored in a dry, non-corrosive atmosphere, non-conductive dust and ambient temperature less than 60 °C.
- This product has a dangerous voltage and it controls a potentially dangerous moving mechanism. Failure to follow these instructions or not complying with the requirements of this manual may result in personal injury or death, damage to the product and associated systems.
- Do not perform wiring work while the power is on, otherwise there is a danger of death due to electric shock. When wiring, inspection, maintenance, etc., please cut off the power of all related equipment and confirm that the DC voltage of the main circuit has dropped to Safety level, wait 5 minutes before performing related work.
- The power cable, motor cable, and control cable must be tightly connected. The grounding terminal must be grounded reliably and the grounding resistance is less than 10Ω.
- The static electricity of the human body will seriously damage the internal sensitive components. Before performing related operations, please observe the measures and methods specified in the static electricity prevention measures (ESD), otherwise the inverter may be damaged.
- Since the output voltage of the inverter is a pulse waveform, if the output side is equipped with a capacitor with improved power factor or a varistor for lightning protection, be sure to remove or modify it on the input side of the inverter.
- Do not add switching devices such as circuit breakers and contactors on the output side of the inverter (if the switching device must be connected to the output side, the output current of the inverter must be zero when the switch is activated).
- No matter where the fault occurs in the control equipment, it may cause a shutdown and a major accident. Therefore, take the necessary external protection measures or spare equipment.
- This product can only be used in accordance with the manufacturer's specified use. It may not be used in special fields such as emergency, rescue, shipbuilding, medical, aviation, nuclear facilities, etc. without permission.
- The maintenance of this product can only be carried out by the company or by a professional authorized by the company. Unauthorized modification and use of accessories not approved by the company may result in product failure. Any defective devices must be replaced in time for maintenance.
- The company is not responsible for any damage or equipment damage caused by your company or your company's customers who fail to comply with the contents of this manual

## 1.2 Before use

Upon receipt of the product you ordered, please check the outsourcing for damage and open the outer packaging after confirming the integrity, and confirm that whether the inverter is damaged, scratched or dirty. (Damage caused during transportation does not belong to our company's

warranty). If the product you received is damaged, please contact the company or the shipping company immediately. After confirming that the received product is intact, please confirm that the received inverter model is consistent with the product you ordered.

### Inverter nameplate and model description

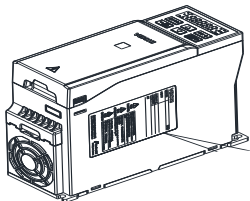

Type code decoding	
Example	RD30-T4-0210-CR-IP20-BU-DC
RD30	Product Series
T4	Voltage class 380V
0210	Rated output current
CR LF	Crane   Lift
IP20	Environmental protection class IP20 or IP54
BU	Brake unit integrated
DC	DC choke integrated
N	No integrated option

Input voltage	220V	380V
Rated power(kW)	Rated output current (A)	
0.75	4	3
1.5	7	4
2.2	10	6.0
4	/	10
5.5	/	13
7.5	/	17
11	/	25
15	/	32
18.5	/	38
22	/	45
30	/	60
37	/	75
45	/	90
55	/	110
75	/	150
90	/	180
110	/	210
132	/	250
160	/	310
185	/	340
200	/	380
220	/	415
250	/	470
280	/	510
315	/	600
355	/	670
400	/	750
450	/	810
500	/	860
560	/	990

## 1.3 Technical specifications

Items		specifications
Power input	Voltage, frequency	Single phase :220V 50/60Hz; Three phase: 220V 50/60Hz; Three phase 380V 50/60Hz ,
	Allowable	voltage unbalance rate:<3%; Frequency:±5%; aberration rate: as IEC61800-2 required
	Inrush current	Lower than rated current
	Power factor	≥0.94(with DC reactor)
	Efficiency	≥96%
Output	Output voltage	Output under rated condition: 3 phase, 0~input voltage, deviation<5%
	Output frequency	G type:0~600Hz
	Output frequency	Max frequency ±0.5%
	Overload capacity	G type: 150% rated current/1 min, 180% rated current/10s, 200% rated current/0.5s P type: 120% rated current/1 min, 140% rated current/10s, 150% rated current/0.5s
Main Control performance	Motor type	Three-phase asynchronous motor; Permanent magnet synchronous motor (sine wave)
	Control mode	V/F control, Open loop vector control, Closed loop vector control
	Modulation	Optimizing Space Voltage Vector PWM Modulation
	Carrier frequency	1.0~16.0kHz
	Speed control range	VC without PG: rated load 1:100; VC with PG: rated load 1:1000
	Steady speed	VC without PG: ≤2% rated synchronized speed; VC with PG: ≤0.05% rated synchronized speed
	Starting torque	VC without PG: 150% rated torque at 0.5Hz; VC with PG: 0Hz, 200% rated torque at 0Hz
	Torque response	VC without PG:<20ms; VC with PG: <10ms
	Frequency accuracy	Digital setting: max frequency×±0.01%; Analog setting: max frequency×±0.2%
Frequency resolution	Digital setting: 0.01Hz; Analog setting: max frequency×0.05%	
Basic functions	Torque control	Torque setting calculation, torque mode speed limit
	DC braking capacity	Starting frequency:0.00~50.00Hz; Braking time:0.0~60.0s; Braking current:0.0~150.0% rated
	Torque boost	Automatic torque boost 0.0%~100.0%; Manual torque boost 0.0%~30.0%
	V/F curve	Four modes: linear torque characteristic curve, self-set V/F curve, torque reduction characteristic curve (1.1 to 2.0 power), square V/F curve
	Acceleration/Deceleration curve	2 modes: linear Acceleration/Deceleration and S curve Acceleration/Deceleration. 4 sets of ACC/DEC, time unit 0.01s selectable, longest time: 650.00s.
	Rated output voltage	Using the power supply voltage compensation function, the rated voltage of the motor is 100%, which can be set within the range of 50 to 100% (the output cannot exceed the input voltage)
	Voltage	While power supply voltage fluctuates, it can auto-keep constant output voltage.
	Auto energy-saving running	While under V/F control mode, according to load situation, auto-optimize output voltage to save energy.
	Auto-limit current	Auto-limit the current while running to prevent over current break trouble.
	Instant power off	Uninterrupted operation through bus voltage control during instantaneous power loss
	Standard functions	PID control, speed track, power off restart, jump frequency, upper/lower frequency limit control, program operation, multi- speed, RS485, analog output, frequency impulse output.
	Frequency setting channels	Keyboard digital setting, Analog voltage/current terminal AI1, Analog voltage/current terminal AI2, Communication given and multi-channel terminal selection, Main and auxiliary channel combination, expansion card, supporting different modes switch
	Feedback input channel	Voltage/Current Terminal AI1, Voltage/Current Terminal AI2, Communication given, Low-speed pulse input PUL, extension card
	Running command	Operation panel given, external terminal given, communication given, expansion card given
Input command signal	Start, stop, FWD/REV, JOG, multi-step speed, free stop, reset, ACC/DEC time selection, frequency given channel selection, external fault alarm.	

	External output signal	1 relay output, 1 collector output, 1 AO output: 0~10V output or 4~20mA output	
Protection function		Overvoltage, under-voltage, current limit, over-current, overload, electric thermal relay, overheat, overvoltage stall, data protection, rapid speed protection, input/output phase failure protection	
Keyboard display	LED display	Built-in keyboard: single line 5- digital tube display	monitor 1 inverter status quantity
		External keyboard: double line 5- digital tube display	Monitor 2 inverter status quantities
	Parameter copy	Upload and download function code information of the inverter for fast parameter copying	
	Status monitor	Output frequency, given frequency, output current, input voltage, output voltage, motor speed, PID feedback, PID given value, module temperature etc. monitor parameters.	
	Error alarm	Over-voltage, under-voltage, over-current, short circuit, phase failure, overload, overheat, overvoltage stall, current limit, or Data protection compromised, current fault health, historical fault record	
Environment	Install place	The altitude is less than 1000 meters, and the derating is more than 1000 meters. The derating is 1% for every 100 meters. No condensation, icing, rain, snow, hail, etc., solar radiation is less than 700W/m <sup>2</sup> , air pressure 70~106kPa	
	Temperature, humidity	-10 ~ +50°C, derating can be used above 40 °C, the maximum temperature is 60 °C (no-load operation), 5%-95%RH(no condensation)	
	Vibration	9~200Hz,5.9m/s <sup>2</sup> (0.6g)	
	Storage temperature	-30—+60°C	
	Installation	Wall hanging	
	Protection degree	IP20	
	Cooling method	Forced air cooling	

## 2 Installation

In order to ensure the safe use of this product by users, maximize the performance of the inverter, and ensure the reliable operation of the inverter, please strictly use the product in accordance with the environment, wiring, ventilation and other requirements described in this chapter.

### Inverter and keyboard dimensions

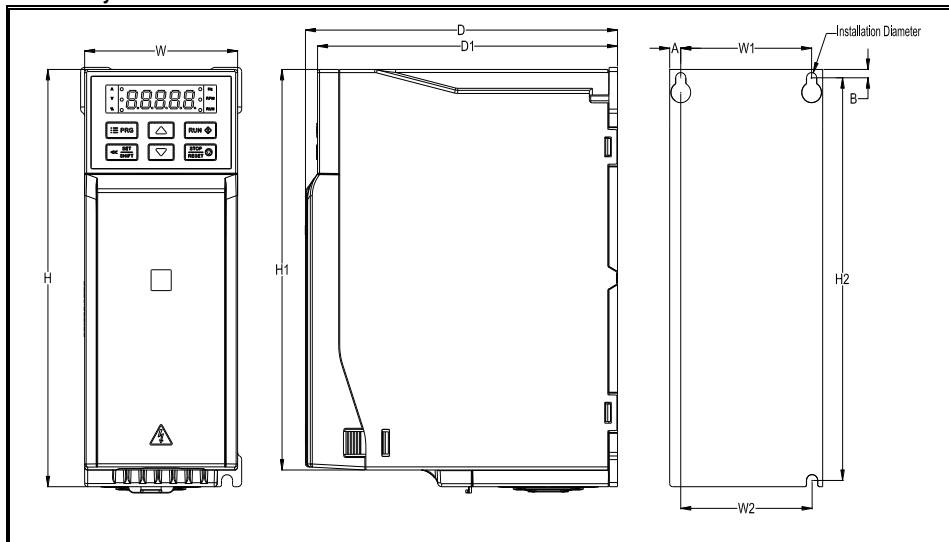

Model	Overall dimension(mm)					Installation dimension(mm)					Aperture
	W	H	H1	D	D1	W1	W2	H2	A	B	
RD30-T4-0003-CR-IP20-BU	76	200	192	155	149	65	65	193	5.5	4	3-M4
RD30-T4-0004-CR-IP20-BU											
RD30-T4-0006-CR-IP20-BU											
RD30-T4-0010-CR-IP20-BU	100	242	231	155	149	84	86.5	231.5	8	5.5	3-M4
RD30-T4-0013-CR-IP20-BU											
RD30-T4-0017-CR-IP20-BU	116	320	307.5	175	169	98	100	307.5	9	6	3-M5
RD30-T4-0025-CR-IP20-BU											

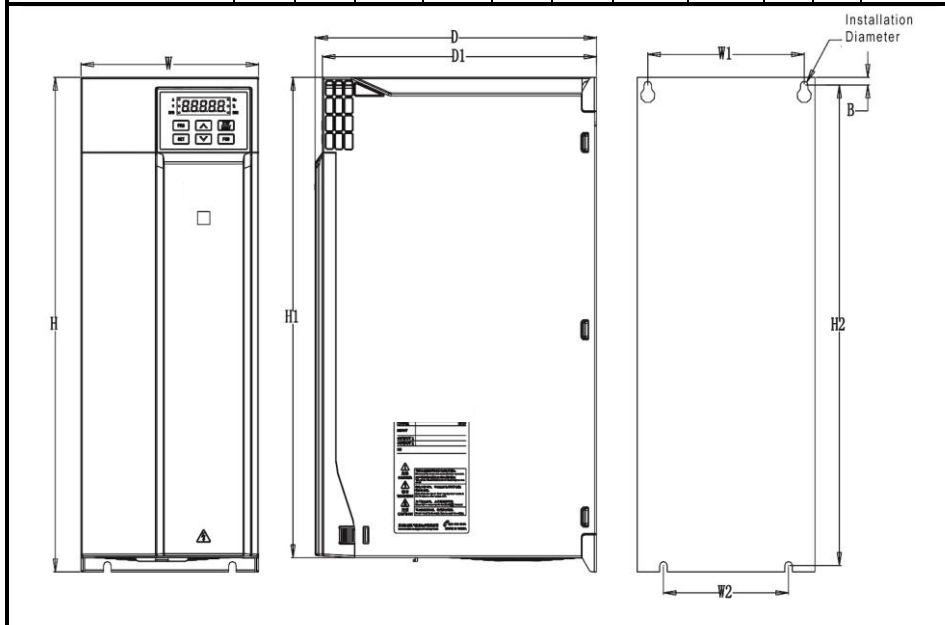

Model	Overall dimension(mm)					Installation dimension(mm)				Aperture
	W	H	H1	D	D1	W1	W2	H2	B	
RD30-T4-0032-CR-IP20-BU	142	383	372	225	219	125	100	372	6	4-M5
RD30-T4-0038-CR-IP20-BU										
RD30-T4-0045-CR-IP20-BU										
RD30-T4-0060-CR-IP20-BU	172	430	/	225	219	150	150	416.5	7.5	4-M5
RD30-T4-0075-CR-IP20-BU										



## Inverter dimensions (iron shell)

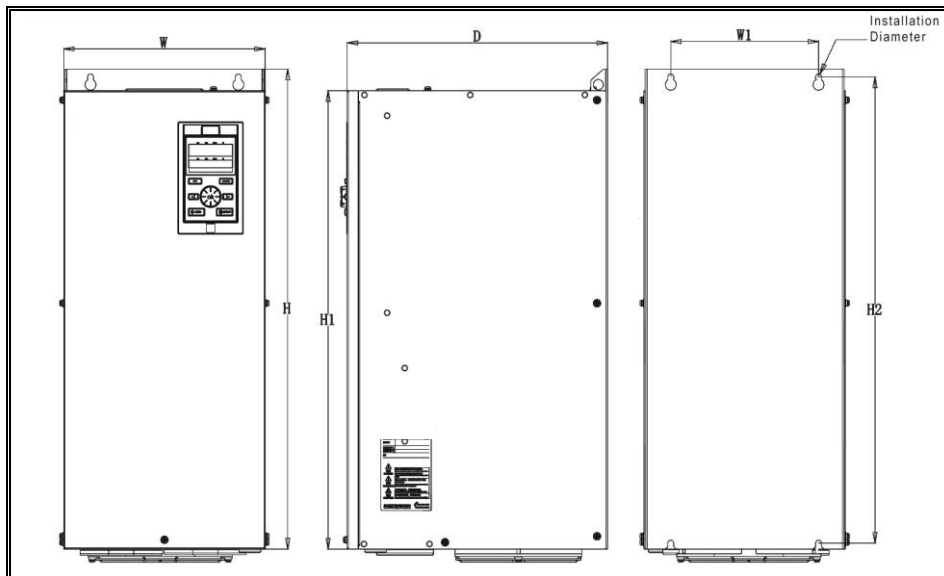

Model	Overall dimension(mm)				Installation dimension(mm)		Aperture
	W	H	H1	D	W1	H2	
RD30-T4-0090-CR-IP20-BU	240	560	520	310	176	544	4-M6
RD30-T4-0110-CR-IP20-BU							
RD30-T4-0150-CR-IP20-N-DC							
RD30-T4-0180-CR-IP20-N-DC	270	638	580	350	195	615	4-M8
RD30-T4-0210-CR-IP20-N-DC							
RD30-T4-0250-CR-IP20-N-DC							
RD30-T4-0310-CR-IP20-N-DC	350	738	680	405	220	715	4-M8
RD30-T4-0340-CR-IP20-N-DC							
RD30-T4-0380-CR-IP20-N-DC							
RD30-T4-0415-CR-IP20-N-DC	360	940	850	480	200	910	4-M16
RD30-T4-0470-CR-IP20-N-DC							
RD30-T4-0510-CR-IP20-N-DC							
RD30-T4-0510-CR-IP20-N-DC	370	1140	1050	545	200	1110	4-M16

Inverter installation space requirements

External keyboard shape and opening size Note: LCD keyboard is fully compatible with LED Ventilation direction and opening size.

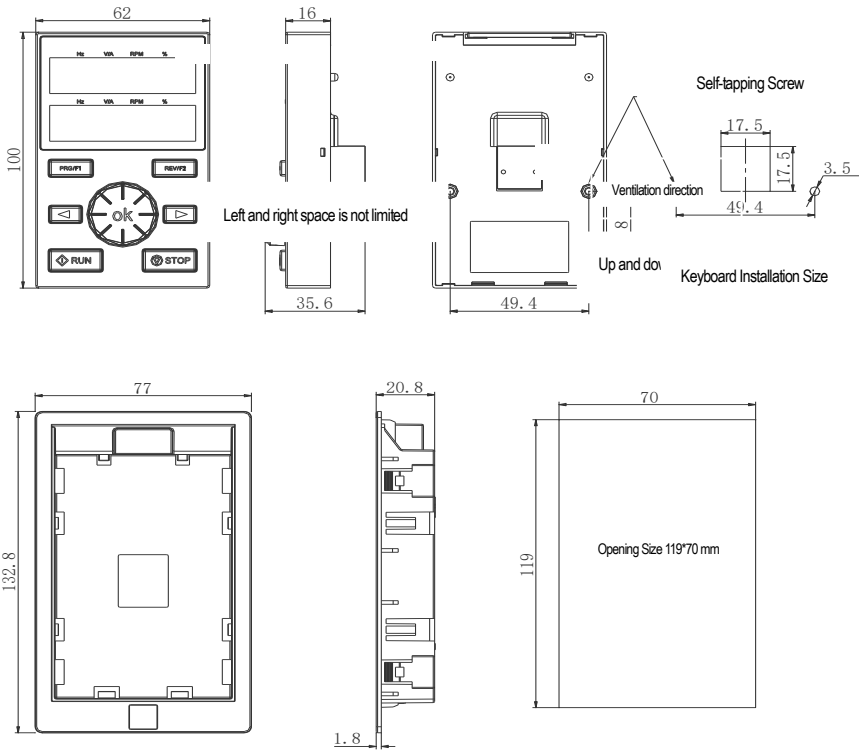

RD30 Series External keyboard pocket shape and opening size

Standard Connection Diagram

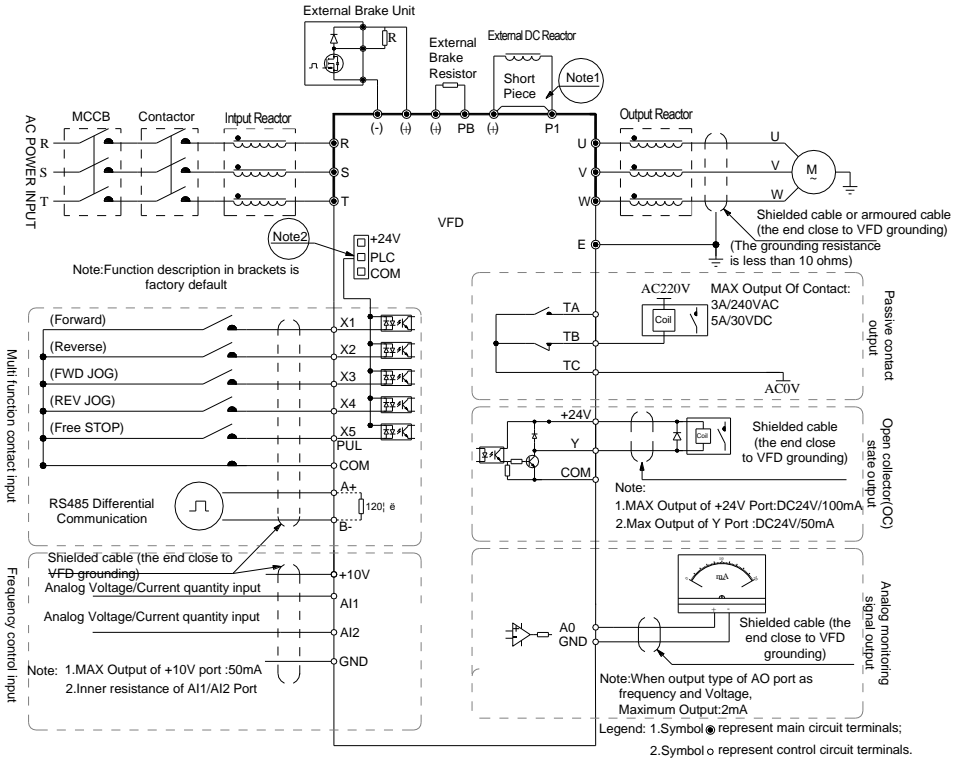

Note: 1. When installing the DC reactor, be sure to remove the shorting tab between the P1 and (+) terminals.

2. The terminal (X1~X5/PUL) can select the NPN or PNP transistor signal as the input, and the bias voltage can select the internal power supply (+24V terminal) or external power supply (PLC terminal) of the inverter.

• Auxiliary Terminal Output Capacity

Terminal	Function Definition	Max Output
+10V	10V auxiliary power supply output, constitutes loop with GND.	50mA
A0	Analog monitor output, constitutes loop with GND.	Max output 2mA as voltage signal
+24V	24V auxiliary power supply output, constitutes loop with COM.	100mA
Y	Collector open circuit output; can set the action-object by program.	DC24V/50mA
TA/TB/TC	Passive connector output; can set the action-object by program.	3A/240VAC; 5A/30VDC

- Function Specification of Switch Terminals

Switch Terminal	Selecting Position	Function Specification
RS485 OFF <input type="checkbox"/> ON AO-F OFF <input type="checkbox"/> ON AO-I OFF <input type="checkbox"/> ON AO-U OFF <input type="checkbox"/> ON AI1 U <input type="checkbox"/> I AI2 U <input type="checkbox"/> I	RS485 Terminal Resistor	RS485 Communication :connect with 120Ω terminal resistor
	AO Output- frequency	AO2: 0.0~100kHz frequency output
	AO Output- Current	AO2: 0~20mA current output or 4~20mA current output
	AO Output- Voltage	0~10V voltage output
	AI1 Input- Current/Voltage	AI1: Input 0~20mA or 0~10V
	AI2 Input- Current/Voltage	AI2: Input 0~20mA or 0~10V

- Some peripheral electrical components instructions

Name	Installation and selection	Function Definition
DC reactor	Installed between the EMC filter and the braking resistor 132kW and above standard	Increase the power factor on the input side; Improve the overall efficiency and thermal stability of the inverter; Effectively eliminate the influence of the input side higher harmonics on the inverter and reduce external conduction and radiation interference.
Break unit	Standard 22kW and below, 22kW or more to 110kW (connected between PB and (+))	For power models above 22kW, please choose our recommended braking unit and braking resistor; The motor consumes regenerative energy through the braking resistor when decelerating.

### 3 Keyboard Layout and Operating Instructions

#### •Keyboard Appearance

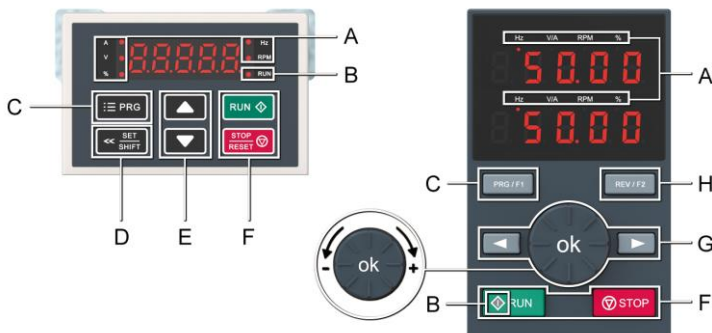

Integrated keyboard (37KW and below)

Double-line keyboard (37KW and above)



#### •Key function

	Integrated	Double-line	Function
A	Unit indicator		Hz: frequency A: current V: voltage V/A: voltage/current RPM: rotate speed %: ratio
B	Status indicator		On: Forward running status Blinking: Reverse running status Off: Stopping
C			Enter the function menu interface during standby or running; press this button to exit the modification when the parameter is modified; press the button (1 second) during standby or running to enter the status interface directly.
D			Confirmation function: After modifying the value, press this key to confirm the modification value. Shift function: long press this button (1 second) to move the operation bit, long press is not loose, then cyclic shift
E			The up key increases the operation value, and the down key decreases the operation value.
F			When the run/stop is controlled by the keyboard, press this button to turn the inverter forward. The status indicator is always on during forward run, and the status indicator is blinking during reverse run.
			When the command given channel is keyboard control, press this key to stop the inverter; the parameter F11.03 [keyboard stop key setting] can be used to define whether other command channels are valid; when the fault state is pressed, the inverter resets.
G			Digital potentiometer: Use clockwise rotation as the upper key to increase the operation value, counterclockwise rotation as the lower key to reduce the operation value.
			Confirmation key: After modifying the value, press this key to confirm the modified value.

			Move left and right
H			Select the function of this key by parameter F11.00 [Keyboard Multi-Function Key Selection]

•Basic parameter group setting

The following is an example of setting F01.22 [acceleration time] = 10.00s to explain the basic operation of the LED operator.

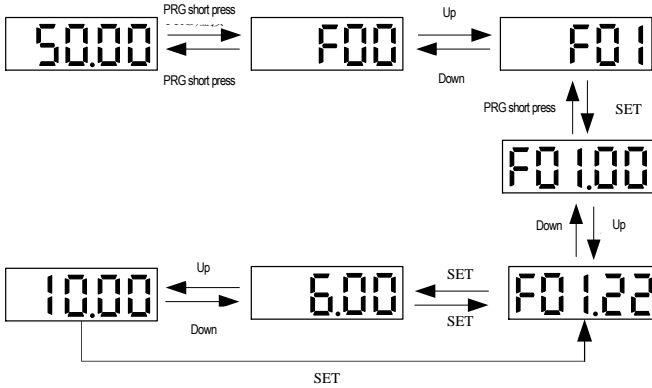

Note: When modifying the ten, hundred and thousand digits of the parameter value, use the keyboard shift key function to quickly select.

• Run monitoring status view

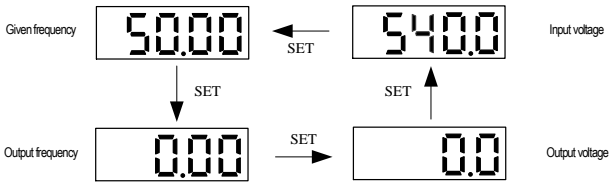

Note: When using the external keyboard, use the left shift button to cycle through the first line of monitoring parameters, and use the right shift button to cycle through the second line of monitoring parameters.

• Monitoring parameter view

The following is an example to illustrate the basic operation of the LED operator at at C02.05 [PLC Operation Phase]

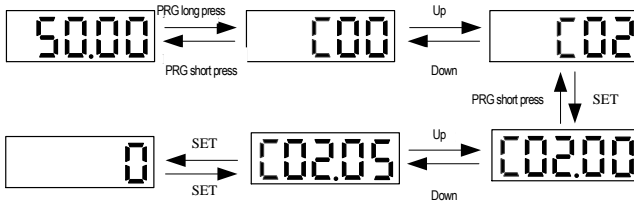

## 4 Function Parameter Table

This chapter only provides a function code summary table. For detailed function description, please refer to the RD30 technical manual or consult our company.

### 4.1 Parameter icon description

#### ◆ Icons and terms that represent control modes

Icon	Description
V/F	Effective parameters in asynchronous motor V/F control mode
SVC	Effective parameters of asynchronous motor open loop vector control
FVC	Effective parameters of closed-loop vector control of asynchronous motor
PMVF	Effective parameters in synchronous motor V/F control mode
PMSVC	Effective parameters of synchronous motor open loop vector control mode
PMFVC	Effective parameters of synchronous motor closed-loop vector control mode

**Note:** The control mode icon has no shadow to indicate that the parameter is invalid in this control mode.

#### ◆ Icons and terms that represent control modes

Icon	Description
RUN	Parameters that can be modified during operation
STOP	Parameters that cannot be modified during operation
READ	This parameter can only be read and cannot be modified (the LED shows 5 "-" when modified)

### 4.2 Parameter content

parameter	name	parameter	name
F00.0x	Environment setting	F06.4x	Frequency detection
F00.1x	Common parameter setting	F06.5x	Monitor parameter comparator output
F01.0x	Basic command	F06.6x	Virtual input and output terminal
F01.1x	Frequency command	F07.0x	Start control
F01.2x	AccDec time	F07.1x	Shutdown control
F01.4x	PWM control	F07.2x	DC braking and speed tracking
F02.0x	Basic motor parameters and self-learning options	F07.3x	JOG
F02.1x	Asynchronous motor advanced parameters	F07.4x	Start, stop frequency maintenance and frequency hopping
F02.2x	Synchronous motor advanced parameters	F08.0x	Counting and timing
F02.3x	Encode parameter	F08.3x	Swing frequency control
F02.5x	Motor application parameter	F10.0x	Current protection
F03.0x	Speed loop	F10.1x	Voltage protection
F03.1x	Current loop and torque limit	F10.2x	Auxiliary protection
F03.2x	Torque optimization control	F10.3x	Load protection
F03.3x	Flux optimization	F10.4x	Stall protection
F03.4x	Torque control	F10.5x	Failure recovery protection
F03.6x	PM high frequency injection	F11.0x	Key operation
F03.7x	Position compensation	F11.1x	Status interface loop monitoring
F03.8x	Extended control	F11.2x	Monitoring parameter control
F04.0x	V/F control	F12.0x	MODBUS slave parameters
F04.1x	Custom V/F curve	F12.1x	MODBUS host parameters
F04.3x	V/F energy saving control	F12.3x	Profibus-DP parameter
F05.0x	Digital input terminal	F12.4x	CANopen parameter
F05.1x	X1-X5 detection delay	F12.5x	Expansion port EX-A, EX-B communication
F05.2x	Digital input terminal action selection	F13.00-F13.06	Feedback and feedback
F05.3x	PUL terminal	F13.07-F13.24	PID adjustment
F05.4x	Analog (AI) type processing	F13.25-F13.28	PID feedback disconnection judgment
F05.5x	Analog (AI) linear processing	F13.29-F13.33	Sleep function
F05.6x	AI curve 1 processing	F14.00-F14.14	Multi-speed frequency given
F05.7x	AI curve 2 processing	F14.15	PLC operation mode selection
F05.8x	AI as a digital input terminal	F14.16-F14.30	PLC running time selection
F06.0x	AO (analog) output	F14.31-F14.45	PLC direction and ACC/DEC time selection
F06.1x	Extended AO output	C00.0x	Basic monitoring
F06.2x	Digital, relay output	C01.0x	Fault monitoring

### 4.3 Environment application

Parameter (Address)	Name	Content	Factory default (range)	Adjustable properly
F00.00 (0x0000)	Parameter access level	<b>V/F SVC FVC PMVF PMSVC PMFVC</b> Set the parameter access level based on the case of restricted parameter access. 0: standard parameter (Fxx.yy) 1: Common parameters (F00.00, Pxx.yy) 2: Monitoring parameters (F00.00, Cxx.yy) 3: Changed parameter(F00.00, Hxx.yy)	0 (0 ~ 3)	RUN
F00.03 (0x0003)	Initialization	<b>V/F SVC FVC PMVF PMSVC PMFVC</b> Set the inverter initialization method. 0: not initialized 11: Select the set value according to the purpose to perform the parameter (excluding the motor parameter) 22: All parameters are initialized 33: Clear the fault record	0 (0 ~ 33)	STOP
F00.04 (0x0004)	Keyboard parameter copy	<b>V/F SVC FVC PMVF PMSVC PMFVC</b> 0: no function 1: Upload parameters to the keyboard 2: Download parameters to the inverter	0 (0 ~ 9999)	STOP
F00.05 (0x0005)	User password	<b>V/F SVC FVC PMVF PMSVC PMFVC</b> Used to set the user password.	0 (0 ~ 65355)	STOP
F00.06 (0x0006)	LCD keyboard language selection	<b>V/F SVC FVC PMVF PMSVC PMFVC</b> Select the language displayed on the LCD operator. 0: Chinese 1: English	0 (0 ~ 1)	RUN
F00.07 (0x0007)	Free parameter 1	<b>V/F SVC FVC PMVF PMSVC PMFVC</b> When using multiple machines, use the machine number or usage mode number	0 (0 ~ 65535)	RUN
F00.08 (0x0008)	Free parameter 2	<b>V/F SVC FVC PMVF PMSVC PMFVC</b> When using multiple machines, use the machine number or usage mode number.	0 (0 ~ 65535)	RUN
F00.10~F00.39 (0x0010 ~ 0x0027)	Common parameter address setting	<b>V/F SVC FVC PMVF PMSVC PMFVC</b> "0~00" digits: yy setting in function parameter number Fxx.yy 00~99 "000~0000" digits: xx setting in function parameter number Fxx.yy 00~31	0102 (0000 ~ 3199)	RUN

### 4.4 F01: Basic Settings

#### F01.0x: Basic command

Parameter (Address)	Name	Content	Factory default (range)	Adjustable properly
F01.00 (0x0100)	Motor control	<b>V/F SVC FVC PMVF PMSVC PMFVC</b> The control mode of the motor. Asynchronous motor control mode: 0: AM-VF; VF control 1: AM-SVC; open loop vector control, current closed loop control 2: AM-FVC; closed loop vector control Synchronous motor control mode: 10: PM-VF; VF control 11: PM-SVC; open loop vector control 12: PM-FVC; closed loop vector control	0 (0 ~ 12)	STOP
F01.01 (0x0101)	Run command channel	<b>V/F SVC FVC PMVF PMSVC PMFVC</b> Used to select the channel that the drive accepts the run and stop commands and the direction of travel. 0: keyboard control (external keyboard priority) 1: terminal control 2: RS485 communication control 3: Option card	0 (0 ~ 3)	RUN
F01.02 (0x0102)	Frequency given channel A	<b>V/F SVC FVC PMVF PMSVC PMFVC</b> The given source channel B of the frequency converter 0: keyboard digital reference frequency 1: keyboard analog potentiometer given 2: Current/voltage analog AI1 given 3: Current/voltage analog AI2 given	0 (0 ~ 11)	RUN



		4: Reserved 5: Terminal pulse PUL given 6: RS485 communication reference 7: Terminal UP/DW control 8: PID control given 9: Program control (PLC) given 10: Optional card 11: Multi-speed speed given		
F01.03 (0x0103)	Frequency reference source channel A gain	V/F SVC FVC PMVF PMSVC PMFVC Frequency reference source channel A gain	100.0 (0.0 ~ 500.0%)	STOP
F01.04 (0x0104)	Frequency given channel B	V/F SVC FVC PMVF PMSVC PMFVC The given source channel B of the frequency converter same as[F01.02]	2 (0 ~ 11)	RUN
F01.05 (0x0105)	Frequency reference source channel B gain	V/F SVC FVC PMVF PMSVC PMFVC Frequency reference source channel B gain	100.0 (0.0 ~ 500.0%)	STOP
F01.06 (0x0106)	Frequency channel B reference source	V/F SVC FVC PMVF PMSVC PMFVC The reference source of frequency given channel B is selected by this parameter. 0: reference source with maximum output frequency 1: Use channel A to set the frequency as the reference source	0 (0 ~ 1)	RUN
F01.07 (0x0107)	Frequency reference source selection	V/F SVC FVC PMVF PMSVC PMFVC It is used to select the combination mode of the inverter setting frequency channel A and channel B. 0: channel A 1: channel B 2: Channel A + Channel B. 3: Channel A-channel B 4: Maximum value of channel A and channel B 5: the minimum of channel A and channel B	0 (0 ~ 5)	RUN
F01.08 (0x0108)	Run command bundled given frequency	V/F SVC FVC PMVF PMSVC PMFVC When this parameter is valid, it is used to set the channel source frequency channel for each running command channel. Units: Bundled with Keyboard command Ten digits: Bundled with Terminal command Hundreds: Bundled with communication command Thousands: Bundled with optional card command 0: no binding 1: keyboard digital given frequency 2: Keyboard analog potentiometer given 3: current / voltage analog AI1 given 4: Current/voltage analog AI2 given 5: Reserved 6: Terminal pulse PUL reference 7: Communication given 8: Terminal UP/DW control 9: PID control given A: Program control given B: Option card C: multi-speed reference D: reserved	0000 (0000 ~ DDDD)	RUN
F01.09 (0x0109)	Keyboard digital given frequency	V/F SVC FVC PMVF PMSVC PMFVC Used to set and modify the keyboard digital setting frequency.	50Hz (0.0 ~ upper limit frequency)	RUN

### F01.1x: Frequency Command

Parameter (Address)	Name	Content	Factory default (range)	Adjustable properly
F01.10 (0x010A)	Maximum frequency	V/F SVC FVC PMVF PMSVC PMFVC The maximum frequency that the frequency converter can set.	50.00Hz (Upper limit frequency ~ 600.00Hz)	STOP
F01.11 (0x010B)	Upper frequency source selection	V/F SVC FVC PMVF PMSVC PMFVC Select a given source for the upper limit frequency of the converter. 0: upper limit frequency digital reference 1: keyboard analog potentiometer given 2: Current/voltage analog AI1 given 3: Current/voltage analog AI2 given 4: Reserved 5: Terminal pulse PUL given 6: RS485 communication reference 7: Option card	0 (0 ~ 7)	RUN
F01.12 (0x010C)	Upper limit frequency digital setting	V/F SVC FVC PMVF PMSVC PMFVC Upper limit frequency given channel when F01.11 is set to 0	50.00Hz (0 ~ Max frequency)	RUN
F01.13 (0x010D)	Lower limit frequency	V/F SVC FVC PMVF PMSVC PMFVC Given a lower frequency limit, the given frequency is limited.	0.00Hz (0 ~ Upper limit frequency)	RUN

## F01.2x-F01.3x: Acceleration and deceleration Time

Parameter (Address)	Name	Content	Factory default (range)	Adjustable properly
F01.20 (0x0114)	Acceleration/deceleration time reference	V/F SVC FVC PMVF PMSVC PMFVC Set the reference frequency to calculate the acceleration/deceleration time. 0: Maximum frequency 1: Fixed frequency 50Hz 2: Set frequency	0 (0~2)	STOP
F01.21 (0x0115)	Acceleration time unit	V/F SVC FVC PMVF PMSVC PMFVC The unit of acceleration time setting. 0.1s 1.0.1s 2.0.01s	2 (0~2)	STOP
F01.22 (0x0116)	Acceleration time 1	V/F SVC FVC PMVF PMSVC PMFVC The time required for the output frequency to accelerate from 0.00 Hz to the reference frequency. 1~6500s(F01.21 = 0) 0.1~6500.0s(F01.21 = 1) 0.01~650.00s(F01.21 = 2)	Model related (0.01 ~ 650.00s)	RUN
F01.23 (0x0117)	Deceleration time 1	V/F SVC FVC PMVF PMSVC PMFVC Time required for the output frequency to decelerate from the reference frequency to 0.00 Hz.	Model related (0.01~650.00s)	RUN
F01.24 (0x0118)	Acceleration time 2	V/F SVC FVC PMVF PMSVC PMFVC Time required for the output frequency to accelerate from 0.00Hz to the reference frequency	Model related (0.01~650.00s)	RUN
F01.25 (0x0119)	Deceleration time 2	V/F SVC FVC PMVF PMSVC PMFVC Time required for the output frequency to decelerate from the reference frequency to 0.00 Hz.	Model related (0.01~650.00s)	RUN
F01.26 (0x011A)	Acceleration time 3	V/F SVC FVC PMVF PMSVC PMFVC Time required for the output frequency to accelerate from 0.00Hz to the reference frequency	Model related (0.01~650.00s)	RUN
F01.27 (0x011B)	Deceleration time 3	V/F SVC FVC PMVF PMSVC PMFVC Time required for the output frequency to decelerate from the reference frequency to 0.00 Hz.	Model related (0.01~650.00s)	RUN
F01.28 (0x011C)	Acceleration time 4	V/F SVC FVC PMVF PMSVC PMFVC Time required for the output frequency to accelerate from 0.00Hz to the reference frequency	Model related (0.01~650.00s)	RUN
F01.29 (0x011D)	Deceleration time 4	V/F SVC FVC PMVF PMSVC PMFVC Time required for the output frequency to decelerate from the reference frequency to 0.00 Hz.	Model related (0.01~650.00s)	RUN
F01.30 (0x011E)	S curve acceleration and deceleration selection	V/F SVC FVC PMVF PMSVC PMFVC S curve acceleration and deceleration selection is valid or invalid 0: invalid 1: valid	1 (0-1)	STOP
F01.31 (0x011F)	S curve acceleration start time	V/F SVC FVC PMVF PMSVC PMFVC Set the S curve acceleration start time.	0.20s (0.00~10.00)	STOP
F01.32 (0x0120)	S curve acceleration end time	V/F SVC FVC PMVF PMSVC PMFVC Set the S curve acceleration end time	0.20s (0.00~10.00)	STOP
F01.33 (0x0121)	S curve deceleration start time	V/F SVC FVC PMVF PMSVC PMFVC Set the S curve deceleration start time.	0.20s (0.00~10.00)	STOP
F01.34 (0x0122)	S curve deceleration end time	V/F SVC FVC PMVF PMSVC PMFVC Set the S curve deceleration end time	0.20s (0.00~10.00)	STOP
F01.35 (0x0123)	Switching frequency between acceleration time 1 and acceleration time 2	V/F SVC FVC PMVF PMSVC PMFVC Set the frequency switch between Acc time 1 and Acc time 2	0.00Hz (0.00~Max frequency)	RUN

## F01.4x: PWM Controlling

Parameter (Address)	Name	Content	Factory default (range)	Adjustable properly
F01.40 (0x0128)	The carrier frequency	V/F SVC FVC PMVF PMSVC PMFVC Use to set the switching frequency of the inverter IGBT.	Model related (1.0~16.0kHz)	RUN

F01.41 (0x0129)	PWM control mode	<b>V/F SVC FVC PMVF PMSVC PMFVC</b> Units: Carrier and temperature are associated 0: Independent of temperature 1: Temperature dependent Tens: carrier is associated with output frequency 0: Independent of output frequency 1: Output frequency dependent Hundreds: random PWM enable 0: Disable 1: Enable Thousands: PWM modulation 0: Only three-phase modulation is used 1: Automatically switched between two-phase and three-phase modulation	1111 (0000 ~ 1111)	RUN
F01.43 (0x012B)	Dead zone compensation gain	<b>V/F SVC FVC PMVF PMSVC PMFVC</b> Dead zone compensation gain	306 (0 ~ 512)	RUN

## 4.5 F02: Motor parameter

### F02.0x: Basic parameter and Self-tuning

Parameter (Address)	Name	Content	Factory default (range)	Adjustable properly
F02.00 (0x0200)	Motor type	<b>V/F SVC FVC PMVF PMSVC PMFVC</b> Set the type of motor 0: Asynchronous motor (AM) 1: Permanent magnet synchronous motor (PM)	0 (0 ~ 1)	READ
F02.01 (0x0201)	Number of motor poles	<b>V/F SVC FVC PMVF PMSVC PMFVC</b> Set the number of motor poles	4 (2 ~ 98)	STOP
F02.02 (0x0202)	Rated power	<b>V/F SVC FVC PMVF PMSVC PMFVC</b> Set the rated power of the motor.	Model related (0.1 ~ 1000.0kW)	STOP
F02.03 (0x0203)	Rated frequency	<b>V/F SVC FVC PMVF PMSVC PMFVC</b> Set the rated power of the motor..	Model related (0.01 ~ Max)	STOP
F02.04 (0x0204)	Rated rotate speed	<b>V/F SVC FVC PMVF PMSVC PMFVC</b> Set the rated rotate speed of the motor.	Model related (0 ~ 6500rpm)	STOP
F02.05 (0x0205)	Rated voltage	<b>V/F SVC FVC PMVF PMSVC PMFVC</b> Set the rated voltage of the motor.	Model related (0 ~ 1500V)	STOP
F02.06 (0x0206)	Rated current	<b>V/F SVC FVC PMVF PMSVC PMFVC</b> Set the rated current of the motor	Model related (0.1 ~ 3000.0A)	STOP
F02.07 (0x0207)	Motor parameter self-tuning selection	<b>V/F SVC FVC PMVF PMSVC PMFVC</b> After the parameter self-tuning is finished, the value of [F02.07] will be automatically set to "0". 0: No operation 1: Rotary self-learning 2: Static self-learning 3: Stator resistance self-learning	0 (0 ~ 3)	STOP

### F02.1x: Motor Senior Parameter

Parameter (Address)	Name	Content	Factory default (range)	Adjustable properly
F02.10 (0x020A)	Asynchronous motor no-load current	<b>V/F SVC FVC PMVF PMSVC PMFVC</b> Set the size of the no-load current of the asynchronous motor.	Model related (0.1 ~ 3000.0A)	STOP
F02.11 (0x020B)	Asynchronous motor stator resistance	<b>V/F SVC FVC PMVF PMSVC PMFVC</b> Set the size of the asynchronous motor stator resistance.	Model related (0.01mΩ ~ 60000mΩ)	STOP
F02.12 (0x020C)	Asynchronous motor rotor resistance	<b>V/F SVC FVC PMVF PMSVC PMFVC</b> Set the size of the asynchronous motor rotor resistance.	Model related (0.01mΩ ~ 60000mΩ)	STOP
F02.13 (0x020D)	Asynchronous motor stator leakage inductance	<b>V/F SVC FVC PMVF PMSVC PMFVC</b> Set the stator leakage inductance of the asynchronous motor.	Model related (0.01mH ~ 65535mH)	STOP
F02.14 (0x020E)	Asynchronous motor stator inductance	<b>V/F SVC FVC PMVF PMSVC PMFVC</b> Set the stator inductance of the asynchronous motor.	Model related (0.01mH ~ 65535mH)	STOP

F02.15 (0x020F)	Stator resistance standard value	V/F SVC FVC PMVF PMSVC PMFVC Set the stator resistance value.	Model related (.01 ~ 50.00%)	READ
F02.16 (0x0210)	Rotor resistance standard value	V/F SVC FVC PMVF PMSVC PMFVC Set the rotor resistance value.	Model related (.01~50.00%)	READ
F02.17 (0x0211)	Stator leakage inductance	V/F SVC FVC PMVF PMSVC PMFVC Set the stator leakage inductance value.	Model related (.01~50.00%)	READ
F02.18 (0x0212)	Stator inductance value	V/F SVC FVC PMVF PMSVC PMFVC Set the stator inductance value	Model related (.1 ~ 999.0%)	READ

### F02.2x: Synchronous Motor Senior Parameter

Parameter (Address)	Name	Content	Factory default (range)	Adjustable properly
F02.20 (0x0214)	Synchronous stator resistance	V/F SVC FVC PMVF PMSVC PMFVC Set the PM stator resistance.	Model related (0.01mΩ ~ 60000mΩ)	STOP
F02.21 (0x0215)	Synchronous machine D-axis inductance	V/F SVC FVC PMVF PMSVC PMFVC Set the D-axis inductance of the PM.	Model related (0.001mH ~ 6563.5mH)	STOP
F02.22 (0x0216)	Synchronous machine Q-axis inductance	V/F SVC FVC PMVF PMSVC PMFVC Set the Q-axis inductance of the PM.	Model related (0.001mH ~ 6563.5mH)	STOP
F02.23 (0x0217)	Synchronous machine back electromotive force	V/F SVC FVC PMVF PMSVC PMFVC Set the back EMF of the PM. It will only be recognized when the rotation is self-tuning.	Model related (0~1500V)	STOP
F02.24 (0x0218)	Synchronous machine encoder mounting angle	V/F SVC FVC PMVF PMSVC PMFVC Set the PM encoder mounting angle.	Model related (.0°~360.0°)	RUN
F02.25 (0x0219)	Synchronous machine stator resistance standard value	V/F SVC FVC PMVF PMSVC PMFVC Set the stator resistance value of the PM	Model related	READ
F02.26 (0x021A)	Synchronous machine D-axis inductance standard value	V/F SVC FVC PMVF PMSVC PMFVC Set the D-axis inductance value of the PM	Model related	READ
F02.27 (0x021B)	Synchronous machine Q-axis inductance standard value	V/F SVC FVC PMVF PMSVC PMFVC Set the Q-axis inductance value of the PM.	Model related	READ
F02.28 (0x021C)	Synchronous motor pulse width coefficient	V/F SVC FVC PMVF PMSVC PMFVC Set the pulse width factor of the PM.	Model related (.00.00~99.99)	STOP

### F02.3x-F02.4x: Encoder Parameter

Parameter (Address)	Name	Content	Factory default (range)	Adjustable properly
F02.30 (0x021E)	Speed feedback encoder type	V/F SVC FVC PMVF PMSVC PMFVC 0: Normal ABZ encoder (extension port EX_B) 1: rotary transformer (connected to the expansion port EX_B)	0 (0~1)	STOP
F02.31 (0x021F)	Encoder direction	V/F SVC FVC PMVF PMSVC PMFVC 0: the same direction 1: the opposite direction	0 (0~1)	STOP
F02.32 (0x0220)	ABZ encoder Z pulse detection selection	V/F SVC FVC PMVF PMSVC PMFVC 0: Off 1: On	1 (0~1)	STOP
F02.33 (0x0221)	ABZ encoder line number	V/F SVC FVC PMVF PMSVC PMFVC Set the number of ABZ encoder lines.	1024 (1~10000)	STOP
F02.34 (0x0222)	Number of resolver poles	V/F SVC FVC PMVF PMSVC PMFVC Set the number of resolver poles.	2 (2~128)	STOP
F02.35 (0x0223)	Encoder transmission ratio numerator	V/F SVC FVC PMVF PMSVC PMFVC Set the encoder drive ratio numerator.	1 (1~32767)	RUN
F02.36 (0x0224)	Encoder gear ratio denominator	V/F SVC FVC PMVF PMSVC PMFVC Set the encoder driven ratio denominator.	1 (1~32767)	RUN
F02.37 (0x0225)	Encoder speed measurement filter	V/F SVC FVC PMVF PMSVC PMFVC Set the encoder speed measurement filter time	1.0ms (0.0~100.0ms)	RUN

	time			
F02.38 (0x0226)	Encoder disconnection detection time	V/F SVC FVC PMVF PMSVC PMFVC	Set the encoder disconnection detection time.	0.500s (0.100~60.000s)

### F02.5x: Motor Application Parameter

Parameter (Address)	Name	Content	Factory default (range)	Adjustable properly
F02.50 (0x0232)	Stator resistance start learning function selection	V/F SVC FVC PMVF PMSVC PMFVC 0: Invalid 1: Learn only without updating Greater than 1: Learn and update	0 (0~3)	STOP
F02.51 (0x0233)	Stator resistance start learning coefficient 1	V/F SVC FVC PMVF PMSVC PMFVC The stator resistance starts the learning factor of 1.	0 (0~1000)	RUN
F02.52 (0x0234)	Stator resistance start learning coefficient 2	V/F SVC FVC PMVF PMSVC PMFVC The stator resistance starts the learning factor of 2.	0 (0~1000)	RUN
F02.53 (0x0235)	Stator resistance start learning coefficient 3	V/F SVC FVC PMVF PMSVC PMFVC The stator resistance starts the learning factor of 3.	0 (0~1000)	RUN
F02.60 (0x023C)	Synchronous motor magnetic pole search function	V/F SVC FVC PMVF PMSVC PMFV Units: closed loop vector 0: Off 1: On 2: On, only for the first time after power-on Tens: open loop vector 0: Off 1: On 2: On, only for the first time after power-on	3010 (0000~3223)	STOP

## 4.6 F03: Vector Controlling

### F03.0x: Speed loop

Parameter (Address)	Name	Content	Factory default (range)	Adjustable properly
F03.00 (0x0300)	ASR speed rigidity level	V/F SVC FVC PMVF PMSVC PMFVC Set the rigidity level, and the higher the level, the better the speed rigidity.	0 (0~100)	RUN
F03.01 (0x0301)	ASR speed rigid mode	V/F SVC FVC PMVF PMSVC PMFVC ASR speed rigid mode	0000 (0000~1111)	RUN
F03.02 (0x0302)	ASR (speed loop) proportional gain 1	V/F SVC FVC PMVF PMSVC PMFVC Set the ASR (speed loop) proportional gain 1.	10.00 (0.01~100.00)	RUN
F03.03 (0x0303)	ASR (speed loop) integration time 1	V/F SVC FVC PMVF PMSVC PMFVC Set the ASR (speed loop) integration time 1.	0.100s (0.000~6.000s)	RUN
F03.04 (0x0304)	ASR filtering time 1	V/F SVC FVC PMVF PMSVC PMFVC Set the ASR filter time 1.	0.0ms (0.0~100.0ms)	RUN
F03.05 (0x0305)	ASR switching frequency 1	V/F SVC FVC PMVF PMSVC PMFVC Set the ASR switching frequency 1	0.00Hz (0.00~Max)	RUN
F03.06 (0x0306)	ASR (speed loop) proportional gain 2	V/F SVC FVC PMVF PMSVC PMFVC Set the ASR (speed loop) proportional gain 2.	10.00 (0.01~100.00)	RUN
F03.07 (0x0307)	ASR (speed loop) integration time 2	V/F SVC FVC PMVF PMSVC PMFVC Set the ASR (speed loop) integration time 2.	0.100s (0.000~6.000s)	RUN
F03.08 (0x0308)	ASR filtering time 2	V/F SVC FVC PMVF PMSVC PMFVC Set the ASR filter time 2.	0.0ms (0.0~100.0ms)	RUN
F03.09 (0x0309)	ASR switching frequency 2	V/F SVC FVC PMVF PMSVC PMFVC Set the ASR switching frequency 2.	0.00Hz (0.00~Max)	RUN

### F03.1x: Current Loop and Torque limit

Parameter (Address)	Name	Content	Factory default (range)	Adjustable properly
F03.10 (0x030A)	Current loop D-axis proportional gain	V/F SVC FVC PMVF PMSVC PMFVC Set the current loop D-axis proportional gain	1.00 (0.001~4.000)	RUN
F03.11 (0x030B)	Current loop D-axis integral gain	V/F SVC FVC PMVF PMSVC PMFVC Set the current loop D-axis integral gain	1.00 (0.001~4.000)	RUN

F03.12 (0x030C)	Current loop Q-axis proportional gain	V/F SVC FVC PMVF PMSVC PMFVC Set the current loop Q-axis proportional gain	1.00 (0.001 ~ 4.000)	RUN
F03.13 (0x030D)	Current loop Q-axis integral gain	V/F SVC FVC PMVF PMSVC PMFVC Set the current loop Q-axis integral gain	1.00 (0.001 ~ 4.000)	RUN
F03.15 (0x030E)	Electric state torque limit	V/F SVC FVC PMVF PMSVC PMFVC Set the motor state torque limit.	250.0% (0.0~400.0%)	RUN
F03.16 (0x030F)	Power generation torque limit	V/F SVC FVC PMVF PMSVC PMFVC Set the power generation torque limit	250.0% (0.0~400.0%)	RUN
F03.17 (0x0312)	Regenerative torque limit at low speed	V/F SVC FVC PMVF PMSVC PMFVC Set the regenerative torque limit at low speed	0.0% (0.0~400.0%)	RUN
F03.18 (0x0313)	Torque limit action frequency amplitude at low speed	V/F SVC FVC PMVF PMSVC PMFVC Set the torque limit action frequency amplitude at low speed	6.00s (0.00 ~ 30.00s)	RUN

### F03.2x: Torque Optimization Controlling

Parameter (Address)	Name	Content	Factory default (range)	Adjustable properly
F03.20 (0x0314)	Synchronous motor low frequency pull-in current	V/F SVC FVC PMVF PMSVC PMFVC The PM motor open loop control is effective, and the larger the pull-in current is, the larger the torque output is..	20.0% (0.0 ~ 50.0%)	RUN
F03.21 (0x0315)	Synchronous motor high frequency pull-in current	V/F SVC FVC PMVF PMSVC PMFVC The PM motor open loop control is effective, and the larger the pull-in current is, the larger the torque output is.	10.0% (0.0 ~ 50.0%)	RUN
F03.22 (0x0316)	Synchronous motor pull-in current frequency	V/F SVC FVC PMVF PMSVC PMFVC The set value 100.0% corresponds to F01.10 [maximum frequency].	10.0% (0.0 ~ 100.0%)	RUN
F03.23 (0x0317)	Asynchronous motor slip compensation	V/F SVC FVC PMVF PMSVC PMFVC Set the asynchronous motor speed slip compensation.	100.0% (0.0 ~ 250.0%)	RUN
F03.24 (0x0318)	Starting torque initial value	V/F SVC FVC PMVF PMSVC PMFVC Set the initial value of the starting torque	0.0% (0.0 ~ 250.0%)	RUN

### F03.3x: Magnetic Flux Optimization

Parameter (Address)	Name	Content	Factory default (range)	Adjustable properly
F03.30 (0x031E)	Weak magnetic feed forward coefficient	V/F SVC FVC PMVF PMSVC PMFVC Set the weak magnetic feed forward coefficient	10.0% (0.0 ~ 500.0%)	RUN
F03.31 (0x031F)	Weak magnetic control gain	V/F SVC FVC PMVF PMSVC PMFVC Set the weak magnetic control gain	10.0% (0.0 ~ 500.0%)	RUN
F03.32 (0x0320)	Weak magnetic current upper limit	V/F SVC FVC PMVF PMSVC PMFVC Set the weak magnetic current upper limit	60.0% (0.0 ~ 250.0%)	RUN
F03.33 (0x0321)	Weak magnetic voltage coefficient	V/F SVC FVC PMVF PMSVC PMFVC Set the weak magnetic voltage coefficient	97.0% (0.0 ~ 120.0%)	RUN
F03.34 (0x0322)	Output power limit	V/F SVC FVC PMVF PMSVC PMFVC Set the output power limit	250.0% (0.0 ~ 400.0%)	RUN
F03.35 (0x0323)	Overexcitation braking gain	V/F SVC FVC PMVF PMSVC PMFVC Set the overexcitation braking gain	100.0% (0.0 ~ 500.0%)	RUN
F03.36 (0x0324)	Overexcitation braking limit	V/F SVC FVC PMVF PMSVC PMFVC Set the overexcitation braking limit	10.0% (0.0 ~ 250.0%)	RUN
F03.37 (0x0325)	Energy efficient operation	V/F SVC FVC PMVF PMSVC PMFVC 0: Off 1: On	0 (0 ~ 1)	RUN
F03.38 (0x0326)	Energy-saving operation excitation lower limit	V/F SVC FVC PMVF PMSVC PMFVC Set the Energy-saving operation excitation lower limit	50.0% (0.0 ~ 80.0%)	RUN
F03.39 (0x0327)	Energy-saving operating filter coefficient	V/F SVC FVC PMVF PMSVC PMFVC Set the Energy-saving operating filter coefficient	0.010s (0.000 ~ 6.000s)	RUN

## F03.4x-F03.5x: Torque Controlling

Parameter (Address)	Name	Content	Factory default (range)	Adjustable properly
F03.40 (0x0328)	Torque control selection	V/F SVC FVC PMVF PMSVC PMFVC 0: speed control mode torque limited 1: torque control mode speed limited	0 (0 ~ 1)	RUN
F03.41 (0x0329)	Torque command given	V/F SVC FVC PMVF PMSVC PMFVC Unit: Channel A Ten: Channel B 0: Keyboard number given 1: Reserved 2: Current/voltage analog AI1 given 3: Current/voltage analog AI2 given 4: Reserved 5: PUL 6: RS485 communication reference 7: Option card Hundreds: command given mode 0: channel A 1: channel B 2: Channel A + Channel B 3: Channel A - Channel B 4: Minimum value of channel A and channel B 5: Maximum value of channel A and channel B	0000 (0000~0577)	RUN
F03.42 (0x032A)	Torque keyboard digital setting	V/F SVC FVC PMVF PMSVC PMFVC Set the torque command given	0.0% (0.0 ~ 100.0%)	RUN
F03.43 (0x032B)	Torque input lower limit	V/F SVC FVC PMVF PMSVC PMFVC Set the torque input lower limit.	0.0% (0.0 ~ 100.00%)	RUN
F03.44 (0x032C)	Lower limit corresponding setting	V/F SVC FVC PMVF PMSVC PMFVC Set the lower limit corresponding value.	0.0% (-200.0 ~ 200.0%)	RUN
F03.45 (0x032D)	Torque input upper limit	V/F SVC FVC PMVF PMSVC PMFVC Set the upper limit of the torque input.	100.0% (0.0 ~ 100.0%)	RUN
F03.46 (0x032E)	Upper limit corresponding setting	V/F SVC FVC PMVF PMSVC PMFVC Set the upper limit corresponding value.	100.0% (-200.0 ~ 200.0%)	RUN
F03.47 (0x032F)	Torque filtering time	V/F SVC FVC PMVF PMSVC PMFVC Set the torque limit action frequency range at low speed.	0.100s (0.000 ~ 6.000s)	RUN
F03.52 (0x0334)	Output torque limit	V/F SVC FVC PMVF PMSVC PMFVC Set the upper limit of the output torque.	150.0% (0.0 ~ 200.0%)	RUN
F03.53 (0x0335)	Output torque lower limit	V/F SVC FVC PMVF PMSVC PMFVC Set the lower limit of the output torque.	0.0% (0.0 ~ 200.0%)	RUN
F03.54 (0x0336)	Torque control forward speed limit selection	V/F SVC FVC PMVF PMSVC PMFVC 0: function code F03.56 setting; 1: reserved 2: AI1×F03.56; 3: AI2×F03.56; 4: Reserved 5: PUL×F03.56; 6: RS485 communication given × F03.56 7: Option card × F03.57	0 (0 ~ 7)	RUN
F03.55 (0x0337)	Torque control reverse speed limit selection	V/F SVC FVC PMVF PMSVC PMFVC 0: Function code F03.57 setting; 1 reserved 2: AI1×F03.57; 3: AI2×F03.57; 4: Reserved 5: PUL×F03.57; 6: RS485 communication given × F03.57 7: Option card × F03.57	0 (0 ~ 7)	RUN
F03.56 (0x0338)	Torque control forward speed maximum speed limit	V/F SVC FVC PMVF PMSVC PMFVC Set the torque control forward maximum speed limit.	100.0% (0.0 ~ 100.0%)	RUN
F03.57 (0x0339)	Torque control reverse maximum speed limit	V/F SVC FVC PMVF PMSVC PMFVC Set the torque control reverse maximum speed limit.	100.0% (0.0 ~ 100.0%)	RUN

## F03.6x: PM High Frequency Injection

Parameter (Address)	Name	Content	Factory default (range)	Adjustable properly
F03.60 (0x033C)	High frequency injection selection	V/F SVC FVC PMVF PMSVC PMFVC Valid under PM motor open loop control 0: Disabled 1~5: Enable. The larger the value, the higher the frequency injected.	0 (0 ~ 5)	STOP
F03.61 (0x033D)	High frequency injection voltage	V/F SVC FVC PMVF PMSVC PMFVC Injection voltage amplitude, related to rated voltage, self-learning results, generally do not need to be modified.	10.0% (0.0 ~ 100.0%)	RUN
F03.62 (0x033E)	High frequency injection cutoff frequency	V/F SVC FVC PMVF PMSVC PMFVC The frequency range of the high frequency injection is relatively high, and the high frequency injection is effective when the motor	10.0% (0.0 ~ 100.0%)	RUN

		speed is less than this value.		
F03.70 (0x0346)	Position compensation control	V/F SVC FVC PMVF PMSVC PMFVC Position compensation control under speed control for zero servo or increased system rigidity	0.0 (0 ~ 250.0)	RUN
F03.71 (0x0347)	Compensation gain	V/F SVC FVC PMVF PMSVC PMFVC Set compensation gain	1.0 (0.0 ~ 100.0)	RUN
F03.72 (0x0348)	Compensation amplitude limit	V/F SVC FVC PMVF PMSVC PMFVC Set the compensation amplitude limit value.	0.0% (0.0 ~ 100.0%)	STOP
F03.73 (0x0349)	Compensation range	V/F SVC FVC PMVF PMSVC PMFVC Set the compensation range.	10.0% (0.0 ~ 100.0%)	STOP
F03.80 (0x0350)	Synchronous motor MTPA gain	V/F SVC FVC PMVF PMSVC PMFVC Set the synchronous motor MTPA gain.	100.0% (0.0 ~ 400.0%)	RUN
F03.81 (0x0351)	Synchronous motor MTPA filter time	V/F SVC FVC PMVF PMSVC PMFV Set the MTPA filter time of the synchronous motor.	1.0ms (0.0 ~ 100.0ms)	RUN

## 4.7 F04 : V/F Controlling

### F04.0x: V/F Controlling

Parameter (Address)	Name	Content	Factory default (range)	Adjustable properly
F04.00 (0x0400)	Linear V/F curve selection	V/F SVC FVC PMVF PMSVC PMFVC Used to select the type of V/F curve to meet different load characteristics. 0: straight V/F curve; 1-9: respectively, a power curve of 1.1-1.9 V/F; 10: square V/F curve; 11: customize V/F curve;	0 (0 ~ 11)	STOP
F04.01 (0x0401)	Torque boost	V/F SVC FVC PMVF PMSVC PMFVC 0.0%: automatic torque boost; 0.1 to 30.0%: manual torque boost	0.0% (0.0 ~ 30.0%)	RUN
F04.02 (0x0402)	Torque boost cutoff frequency	V/F SVC FVC PMVF PMSVC PMFVC Set the effective range of the torque boost function. When the output frequency exceeds this value, the torque boost function is cut off.	100.0% (0.0 ~ 100.0%)	RUN
F04.03 (0x0403)	Slip compensation gain	V/F SVC FVC PMVF PMSVC PMFVC Set the slip compensation gain.	0.0% (0.0 ~ 200.0%)	RUN
F04.04 (0x0404)	Slip compensation limit	V/F SVC FVC PMVF PMSVC PMFVC Set the slip compensation limit value.	100.0% (0.0 ~ 300.0%)	RUN
F04.05 (0x0405)	Slip compensation filter time	V/F SVC FVC PMVF PMSVC PMFVC The slip compensation function needs to correctly input the motor nameplate parameters and learn the parameters to achieve the best results.	0.200 (0.000 ~ 6.000)	RUN
F04.06 (0x0406)	Oscillation suppression gain	V/F SVC FVC PMVF PMSVC PMFVC By adjusting this value, low frequency resonance can be suppressed, but not too large, otherwise it will cause additional stability problems..	100.0% (0.0 ~ 900.0%)	RUN
F04.07 (0x0407)	Oscillation suppression filter time	V/F SVC FVC PMVF PMSVC PMFVC Set the oscillation suppression filter time.	1.0 (0.0 ~ 100.0s)	RUN
F04.08 (0x0408)	Output voltage percentage	V/F SVC FVC PMVF PMSVC PMFVC Set the output voltage percentage	100.0% (25.0 ~ 120.0%)	STOP

### F04.1x: Custom V/F Curve

Parameter (Address)	Name	Content	Factory default (range)	Adjustable properly
F04.10 (0x040A)	Self-setting voltage V1	V/F SVC FVC PMVF PMSVC PMFVC Self-setting voltage V1	3.0% (0.0 ~ 100.0%)	STOP
F04.11 (0x040B)	Self-set frequency F1	V/F SVC FVC PMVF PMSVC PMFVC Self-set frequency F1	1.00Hz (0.00~Max)	STOP



F04.12 (0x040C)	Self-setting voltage V2	V/F SVC FVC PMVF PMSVC PMFVC Self-setting voltage V2	28.0% (0.0 ~ 100.0%)	STOP
F04.13 (0x040D)	Self-set frequency F2	V/F SVC FVC PMVF PMSVC PMFVC Self-set frequency F2	10.0Hz (0.00~ Max)	STOP
F04.14 (0x040E)	Self-setting voltage V3	V/F SVC FVC PMVF PMSVC PMFVC Self-setting voltage V3	55.0% (0.0 ~ 100.0%)	STOP
F04.15 (0x040F)	Self-set frequency F3	V/F SVC FVC PMVF PMSVC PMFVC Self-set frequency F3	25.00Hz (0.00~ Max)	STOP
F04.16 (0x0410)	Self-setting voltage V4	V/F SVC FVC PMVF PMSVC PMFVC Self-setting voltage V4	78.0% (0.0 ~ 900.0%)	STOP
F04.17 (0x0411)	Self-set frequency F4	V/F SVC FVC PMVF PMSVC PMFVC Self-set frequency F4	37.5Hz (0.00~ Max)	STOP
F04.18 (0x0412)	Self-setting voltage V5	V/F SVC FVC PMVF PMSVC PMFVC Self-setting voltage V5	100.0% (0.0 ~ 100.0%)	STOP
F04.19 (0x0413)	Self-set frequency F5	V/F SVC FVC PMVF PMSVC PMFVC Self-set frequency F5	50.0Hz (0.00~ Max)	STOP

**F04.2x: Reserved****F04.3x: V/F Energy Saving Controlling**

Parameter (Address)	Name	Content	Factory default (range)	Adjustable properly
F04.30 (0x041E)	Automatic energy saving control	V/F SVC FVC PMVF PMSVC PMFVC 0: Off 1: On	0 (0 ~ 1)	STOP
F04.31 (0x041F)	Energy saving step-down frequency lower limit	V/F SVC FVC PMVF PMSVC PMFVC Set the lower limit of the energy saving step-down frequency.	15.0Hz (0.0~50.0Hz)	STOP
F04.32 (0x0420)	Energy-saving step-down voltage lower limit	V/F SVC FVC PMVF PMSVC PMFVC Set the lower limit of the energy-saving step-down voltage.	50.0% (20.0~100.0%)	STOP
F04.33 (0x0421)	Energy-saving step-down voltage	V/F SVC FVC PMVF PMSVC PMFVC Set the energy-saving step-down voltage regulation rate.	0.010V/MS (0.000~ 0.200 V/MS)	RUN
F04.34 (0x0422)	Adjustment rate	V/F SVC FVC PMVF PMSVC PMFVC Set the energy saving voltage recovery rate.	0.20V/MS (0.00~ 2.00 V/MS)	RUN

**4.8 F05: Input Terminal****F05.0x: Digital Input Terminal Function**

Parameter (Address)	Name	Content	Factory default (range)	Adjustable properly
F05.00 (0x0500)	Terminal X1 function selection	V/F SVC FVC PMVF PMSVC PMFVC See the function of the terminal for details.	1 (0 ~ 95)	STOP
F05.01 (0x0501)	Terminal X2 function selection	V/F SVC FVC PMVF PMSVC PMFVC See the function of the terminal for details.	2 (0 ~ 95)	STOP
F05.02 (0x0502)	Terminal X3 function selection	V/F SVC FVC PMVF PMSVC PMFVC See the function of the terminal for details.	4 (0 ~ 95)	STOP
F05.03 (0x0503)	Terminal X4 function selection	V/F SVC FVC PMVF PMSVC PMFVC See the function of the terminal for details.	5 (0 ~ 95)	STOP
F05.04 (0x0504)	Terminal X5 function selection	V/F SVC FVC PMVF PMSVC PMFVC See the function of the terminal for details.	6 (0 ~ 95)	STOP
F05.05 (0x0505)	Terminal X6 function selection	V/F SVC FVC PMVF PMSVC PMFVC See the function of the terminal for details.	0 (0 ~ 95)	STOP
F05.06 (0x0506)	Terminal X7 function selection	V/F SVC FVC PMVF PMSVC PMFVC See the function of the terminal for details.	0 (0 ~ 95)	STOP
F05.07 (0x0507)	Terminal X8 function selection	V/F SVC FVC PMVF PMSVC PMFVC See the function of the terminal for details.	0 (0 ~ 95)	STOP
F05.08 (0x0508)	Terminal X9 function selection	V/F SVC FVC PMVF PMSVC PMFVC See the function of the terminal for details.	0 (0 ~ 95)	STOP

F05.09 (0x0509)	Terminal X10 function selection	V/F SVC FVC PMVF PMSVC PMFVC See the function of the terminal for details.	0 (0 ~ 95)	STOP
--------------------	---------------------------------	---	---------------	------

**F05.1x: Detection Delay**

Parameter (Address)	Name	Content	Factory default (range)	Adjustable properly
F05.10 (0x050A)	X1 effective detection delay	V/F SVC FVC PMVF PMSVC PMFVC The delay time corresponding to the input terminal X1 transit from the inactive state to the active state	0.010 (0.000 ~ 6.000s)	RUN
F05.11 (0x050B)	X1 invalid detection delay	V/F SVC FVC PMVF PMSVC PMFVC The delay time corresponding to the input terminal X1 transit from the active state to the inactive state	0.010 (0.000 ~ 6.000s)	RUN
F05.12 (0x050C)	X2 effective detection delay	V/F SVC FVC PMVF PMSVC PMFVC The delay time corresponding to the input terminal X2 transit from the inactive state to the active state	0.010 (0.000 ~ 6.000s)	RUN
F05.13 (0x050D)	X2 invalid detection delay	V/F SVC FVC PMVF PMSVC PMFVC The delay time corresponding to the input terminal X2 transit from the active state to the inactive state	0.010 (0.000 ~ 6.000s)	RUN
F05.14 (0x050E)	X3 effective detection delay	V/F SVC FVC PMVF PMSVC PMFVC The delay time corresponding to the input terminal X3 transit from the inactive state to the active state	0.010 (0.000 ~ 6.000s)	RUN
F05.15 (0x050F)	X3 invalid detection delay	V/F SVC FVC PMVF PMSVC PMFVC The delay time corresponding to the input terminal X3 transit from the active state to the inactive state	0.010 (0.000 ~ 6.000s)	RUN
F05.16 (0x0510)	X4 effective detection delay	V/F SVC FVC PMVF PMSVC PMFVC The delay time corresponding to the input terminal X4 transit from the inactive state to the active state	0.010 (0.000 ~ 6.000s)	RUN
F05.17 (0x0511)	X4 invalid detection delay	V/F SVC FVC PMVF PMSVC PMFVC The delay time corresponding to the input terminal X4 transit from the active state to the inactive state	0.010 (0.000 ~ 6.000s)	RUN
F05.18 (0x0512)	X5 effective detection delay	V/F SVC FVC PMVF PMSVC PMFVC The delay time corresponding to the input terminal X5 transit from the inactive state to the active state	0.010 (0.000 ~ 6.000s)	RUN
F05.19 (0x0513)	X5 invalid detection delay	V/F SVC FVC PMVF PMSVC PMFVC The delay time corresponding to the input terminal X5 transit from the active state to the inactive state	0.010 (0.000 ~ 6.000s)	RUN

**F05.2x: Terminal Movement Selection**

Parameter (Address)	Name	Content	Factory default (range)	Adjustable properly
F05.20 (0x0514)	Terminal control mode	V/F SVC FVC PMVF PMSVC PMFVC 0: Two-wire system 1: Two-wire system 2 2: Three-wire system 1 3: Three-wire system 2 Note: See Appendix 2 for terminal wiring.	0 (0 ~ 3)	STOP
F05.22 (0x0516)	X1 ~ X4 terminal characteristics selection	V/F SVC FVC PMVF PMSVC PMFVC 0: Valid when closed 1: valid when disconnected Unit: X1 terminal Ten: X2 terminal Hundreds place: X3 terminal Thousands: X4 terminal	0000 (0000 ~ 1111)	RUN
F05.23 (0x0517)	X5 ~ X8 terminal characteristics selection	V/F SVC FVC PMVF PMSVC PMFVC 0: Valid when closed 1: valid when disconnected Unit: X5 terminal Ten: X6 terminal Hundreds place: X7 terminal Thousands: X8 terminal	0000 (0000 ~ 1111)	RUN
F05.24 (0x0518)	X9 ~ X10 terminal characteristics selection	V/F SVC FVC PMVF PMSVC PMFVC 0: Valid when closed 1: valid when disconnected Unit: X9 terminal Ten: X10 terminal	0000 (0000 ~ 1111)	RUN
F05.25 (0x0519)	Terminal UP/DW control selection	V/F SVC FVC PMVF PMSVC PMFVC 0: The frequency will be stored when power down 1: The frequency won't be stored when power down 2: Adjustable during operation stop and clean	0 (0 ~ 2)	STOP
F05.26 (0x051A)	Terminal UP/DW controls frequency increase and decrease rate	V/F SVC FVC PMVF PMSVC PMFVC Set terminal UP/DW to control the frequency increase and decrease rate	0.50Hz/s (0.01~50.00Hz/s)	RUN
F05.27 (0x051B)	Terminal emergency stop deceleration time	V/F SVC FVC PMVF PMSVC PMFVC Set terminal emergency stop deceleration time	1.00s (0.01 ~ 650.00s)	RUN

## F05.3x: PUL Terminal

Parameter (Address)	Name	Content	Factory default (range)	Adjustable properly
F05.30 (0x051E)	PUL source	V/F SVC FVC PMVF PMSVC PMFVC 0: X5 (maximum 5.000kHz) 1: Expansion port X10 (maximum 100.00kHz) 2: X5 (maximum 100.00kHz)	0 (0~2)	STOP
F05.31 (0x051F)	PUL input minimum frequency	V/F SVC FVC PMVF PMSVC PMFVC The minimum frequency accepted by the PUL, below the frequency signal of this value, the frequency converter will be processed at the minimum frequency.	0.00kHz (0.00~500.00kHz)	RUN
F05.32 (0x0520)	PUL minimum frequency corresponding setting	V/F SVC FVC PMVF PMSVC PMFVC Corresponding to the percentage of the set value	0.00% (0.00~100.00%)	RUN
F05.33 (0x0521)	PUL input maximum frequency	V/F SVC FVC PMVF PMSVC PMFVC The maximum frequency accepted by the PUL, above the frequency signal of this value, the frequency converter will process at the maximum frequency. 0.00~50.00kHz	50.00kHz (0.00~500.00kHz)	RUN
F05.34 (0x0522)	PUL maximum frequency corresponding setting	V/F SVC FVC PMVF PMSVC PMFVC Corresponding to the percentage of the set value	100.00% (0.00~100.00%)	RUN
F05.35 (0x0523)	PUL filter time	V/F SVC FVC PMVF PMSVC PMFVC The size of the input pulse signal is filtered to eliminate the interference signal.	0.100s (0.000~9.000s)	RUN
F05.36 (0x0524)	PUL cutoff frequency	V/F SVC FVC PMVF PMSVC PMFVC Below the frequency of this parameter, the drive is no longer recognized. Processed at 0 Hz.	0.010kHz (0.000~1.000kHz)	RUN

## F05.4x: Analog Input (AI) Treatment

Parameter (Address)	Name	Content	Factory default (range)	Adjustable properly
F05.40 (0x0528)	AI input signal type selection method	V/F SVC FVC PMVF PMSVC PMFVC 0: DIP switch 1: parameter setting	0 (0 ~ 1)	RUN
F05.41 (0x0529)	AI1 input signal type	V/F SVC FVC PMVF PMSVC PMFVC 0: Voltage range 0~10.00V1: Current range0~20.00mA	0 (0 ~ 1)	RUN
F05.42 (0x052A)	AI2 input signal type	V/F SVC FVC PMVF PMSVC PMFVC 0: Voltage range 0~10.00V1: Current range0~20.00mA	0 (0 ~ 1)	RUN
F05.43 (0x052B)	Analog input curve selection	V/F SVC FVC PMVF PMSVC PMFVC Units: AI1 Tens: AI2 0: straight line (default) 1: curve 1 2: curve 2	0000 (0000~0022)	RUN
F05.50 (0x0532)	AI1 lower limit	V/F SVC FVC PMVF PMSVC PMFVC Define the signal received by the AI1 terminal. The voltage signal below this value is processed by the limit value.	0.0% (0.0~100.0%)	RUN
F05.51 (0x0533)	AI1 lower limit corresponding setting	V/F SVC FVC PMVF PMSVC PMFVC Set the percentage of the corresponding set value	0.00% (-100.00~100.00%)	RUN
F05.52 (0x0534)	AI1 upper limit	V/F SVC FVC PMVF PMSVC PMFVC Define the signal received by the AI1 terminal. The voltage signal higher than this value is processed according to the upper limit value.	100.0% (0.0~100.0%)	RUN
F05.53 (0x0535)	AI1 upper limit corresponding setting	V/F SVC FVC PMVF PMSVC PMFVC Set the percentage of the corresponding set value	100.00% (-100.00~100.00%)	RUN
F05.54 (0x0536)	AI1 filtering time	V/F SVC FVC PMVF PMSVC PMFVC Define the size of the analog signal to be used to eliminate interfering signals.	0.010s (0.000~6.000s)	RUN
F05.55 (0x0537)	AI2 lower limit	V/F SVC FVC PMVF PMSVC PMFVC Define the signal received by the AI2 terminal, The voltage signal below this value is processed by the limit value.	0.0% (0.0~100.0%)	RUN
F05.56 (0x0538)	AI2 lower limit corresponding setting	V/F SVC FVC PMVF PMSVC PMFVC Set the percentage of the corresponding set value	0.00% (-100.00~100.00%)	RUN
F05.57 (0x0539)	AI2 upper limit	V/F SVC FVC PMVF PMSVC PMFVC Define the signal received by the AI2 terminal. The voltage signal higher than this value is processed according to the upper limit	100.0% (0.0~100.0%)	RUN

		value.		
F05.58 (0x053A)	AI2 upper limit corresponding setting	<b>V/F SVC FVC PMVF PMSVC PMFVC</b> Set the percentage of the corresponding set value	100.00% (-100.00~100.00%)	RUN
F05.59 (0x053B)	AI2 filter time	<b>V/F SVC FVC PMVF PMSVC PMFVC</b> Define the size of the analog signal to be used to eliminate interfering signals.	0.010s (0.000~6.000s)	RUN
F05.60 (0x053C)	Curve 1 lower limit	<b>V/F SVC FVC PMVF PMSVC PMFVC</b> Set the lower limit of curve 1	0.0% (0.0~100.0%)	RUN
F05.61 (0x053D)	Curve 1 lower limit corresponding setting	<b>V/F SVC FVC PMVF PMSVC PMFVC</b> Set the corresponding percentage	0.00% (0.00~100.00%)	RUN
F05.62 (0x053E)	Curve 1 inflection point 1 input voltage	<b>V/F SVC FVC PMVF PMSVC PMFVC</b> Set curve 1 inflection point 1 input voltage	30.0% (0.0~100.0%)	RUN
F05.63 (0x053F)	Curve 1 inflection point 1 corresponding setting	<b>V/F SVC FVC PMVF PMSVC PMFVC</b> Set the corresponding percentage	30.00% (0.00~100.00%)	RUN
F05.64 (0x0540)	Curve 1 inflection point 2 input voltage	<b>V/F SVC FVC PMVF PMSVC PMFVC</b> Set curve 1 inflection point 2 input voltage	60.0% (0.0~100.0%)	RUN
F05.65 (0x0541)	Curve 1 inflection point 2 corresponding setting	<b>V/F SVC FVC PMVF PMSVC PMFVC</b> Set the corresponding percentage	60.00% (0.00~100.00%)	RUN
F05.66 (0x0542)	Curve 1 upper limit	<b>V/F SVC FVC PMVF PMSVC PMFVC</b> Set the upper limit of curve 1	100.0% (0.0~100.0%)	RUN
F05.67 (0x0543)	Curve 1 upper limit corresponding setting	<b>V/F SVC FVC PMVF PMSVC PMFVC</b> Set the corresponding percentage	100.00% (0.00~100.00%)	RUN
F05.70 (0x0546)	Curve 2 lower limit	<b>V/F SVC FVC PMVF PMSVC PMFVC</b> Set the lower limit of curve 2	0.0% (0.0~100.0%)	RUN
F05.71 (0x0547)	Curve 2 lower limit corresponding setting	<b>V/F SVC FVC PMVF PMSVC PMFVC</b> Set the corresponding percentage	0.00% (0.00~100.00%)	RUN
F05.72 (0x0548)	Curve 2 inflection point 1 input voltage	<b>V/F SVC FVC PMVF PMSVC PMFVC</b> Set curve 2 inflection point 1 input voltage	30.0% (0.0~100.0%)	RUN
F05.73 (0x0549)	Curve 2 inflection point 1 corresponding setting	<b>V/F SVC FVC PMVF PMSVC PMFVC</b> Set the corresponding percentage	30.00% (0.00~100.00%)	RUN
F05.74 (0x054A)	Curve 2 inflection point 2 input voltage	<b>V/F SVC FVC PMVF PMSVC PMFVC</b> Set curve 2 inflection point 1 input voltage	60.0% (0.0~100.0%)	RUN
F05.75 (0x054B)	Curve 2 inflection point 2 corresponding setting	<b>V/F SVC FVC PMVF PMSVC PMFVC</b> Set the corresponding percentage	60.00% (0.00~100.00%)	RUN
F05.76 (0x054C)	Curve 2 upper limit	<b>V/F SVC FVC PMVF PMSVC PMFVC</b> Set the upper limit of curve 2	100.0% (0.00~100.0%)	RUN
F05.77 (0x054D)	Curve 2 upper limit corresponding setting	<b>V/F SVC FVC PMVF PMSVC PMFVC</b> Set the corresponding percentage	100.00% (0.00~100.00%)	RUN
F05.80 (0x0550)	AI terminal for digital input	<b>V/F SVC FVC PMVF PMSVC PMFVC</b> 0: valid at low level 1: valid at high level Unit: AI1 Tens: AI2	0000 (0000~1111)	RUN
F05.81 (0x0551)	Terminal characteristics selection	<b>V/F SVC FVC PMVF PMSVC PMFVC</b> See the function of the terminal for details.	0 (0~63)	STOP
F05.82 (0x0552)	AI terminal function selection (as X terminal)	<b>V/F SVC FVC PMVF PMSVC PMFVC</b> The input setting is higher than the high level setting, which is the input high level.	70.00% (0.00~100.00%)	RUN
F05.83 (0x0553)	AI high level setting	<b>V/F SVC FVC PMVF PMSVC PMFVC</b> Less than the low level setting is low level.	30.00% (0.00~100.00%)	RUN

## 4.9 F06: Output Terminal

Parameter (Address)	Name	Content	Factory default (range)	Adjustable property
F06.00 (0x0600)	AO Output Mode	V/F SVC FVC PMVF PMSVC PMFVC 0: 0~10V 1: 4.00~20.00mA 2: 0.00~20.00mA 3: FM frequency pulse output	0 (0~3)	RUN
F06.01 (0x0601)	AO Output Selection	V/F SVC FVC PMVF PMSVC PMFVC 0: given frequency 1: output frequency 2: Output current 3: Input voltage 4: Output voltage 5: Mechanical speed 6: given torque 7: output torque 8: PID given amount 9: PID feedback amount 10: Output power 11: Bus voltage 12: AI1 input value 13: AI2 input value 14: Reserved 15: PUL input value 16: Module temperature 1 17: Module temperature 2 18:485 communication given 19: virtual vY1 function	0 (0~19)	RUN
F06.02 (0x0602)	AO output gain	V/F SVC FVC PMVF PMSVC PMFVC Adjust the value of the analog output of the terminal.	100.0% (0.0~200.0%)	RUN
F06.03 (0x0603)	AO output bias	V/F SVC FVC PMVF PMSVC PMFVC Set the AO output offset to adjust the zero point of the terminal output.	0.0% (-10.0~10.0%)	RUN
F06.04 (0x0604)	AO output filtering	V/F SVC FVC PMVF PMSVC PMFVC The size of the analog signal is filtered to eliminate interfering signals..	0.01s (0.0~6.00s)	RUN

### F06.1x: AO Extension

Parameter (Address)	Name	Content	Factory default (range)	Adjustable property
F06.10 (0x060A)	Extended AO output mode selection	V/F SVC FVC PMVF PMSVC PMFVC 0: 0~10V 1: 4.00~20.00mA 2: 0.00~20.00mA 3:FM frequency pulse output	0 (0~3)	RUN
F06.11 (0x060B)	Extended AO output selection	V/F SVC FVC PMVF PMSVC PMFVC Corresponding to the extended AO output selection, the same as the F06.01 selection	1 (0~19)	RUN
F06.12 (0x060C)	Extended AO output gain	V/F SVC FVC PMVF PMSVC PMFVC Adjust the value of the analog output of the terminal.	100.0% (0.0~200.0%)	RUN
F06.13 (0x060D)	Extended AO output offset	V/F SVC FVC PMVF PMSVC PMFVC Set the AO output offset to adjust the zero point of the terminal output.	0.0% (-10.0~10.0%)	RUN
F06.14 (0x060E)	Extended AO output filtering	V/F SVC FVC PMVF PMSVC PMFVC The size of the analog signal is filtered to eliminate interfering signals.	0.01s (0.0~6.00s)	RUN

### F06.2x-F06.3x: Digital, Relay Output

Parameter (Address)	Name	Content	Factory default (range)	Adjustable property
F06.20 (0x0614)	Output terminal polarity selection	V/F SVC FVC PMVF PMSVC PMFVC Unit digit: Y terminal Ten digit: Relay output terminal 1 0: positive polarity 1: negative polarity	0000 (0000~1111)	RUN
F06.21 (0x0615)	Output terminal Y	V/F SVC FVC PMVF PMSVC PMFVC See terminal Y function	1 (0~63)	RUN
F06.22 (0x0616)	Relay 1 output (TA-TB-TC)	V/F SVC FVC PMVF PMSVC PMFVC See terminal Y function	4 (0~63)	RUN
F06.25 (0x0619)	Y output ON delay time	V/F SVC FVC PMVF PMSVC PMFVC Set the Y output ON delay time.	0.010s (0.000~60.000s)	RUN

F06.26 (0x061A)	Relay 1 output ON delay time	V/F SVC FVC PMVF PMSVC PMFVC Set relay 1 output the ON delay time	0.010s (0.000~60.000s)	RUN
F06.27 (0x061B)	Extended Y output ON delay time	V/F SVC FVC PMVF PMSVC PMFVC Set the extended Y output ON delay time.	0.010s (0.000~60.000s)	RUN
F06.28 (0x061C)	Extended relay 2ON delay time	V/F SVC FVC PMVF PMSVC PMFVC Set the expansion relay 2 to output the ON delay time	0.010s (0.000~60.000s)	RUN
F06.29 (0x061D)	Y output OFF delay time	V/F SVC FVC PMVF PMSVC PMFVC Set the Y output OFF delay time.	0.010s (0.000~60.000s)	RUN
F06.30 (0x061E)	Relay 1 output OFF delay time	V/F SVC FVC PMVF PMSVC PMFVC Set relay 1 output OFF delay time.	0.010s (0.000~60.000s)	RUN
F06.31 (0x061F)	Extended Y1 output OFF delay time	V/F SVC FVC PMVF PMSVC PMFVC Set the extended Y1 output OFF delay time	0.010s (0.000~60.000s)	RUN
F06.32 (0x0620)	Extended relay 2 output OFF delay time	V/F SVC FVC PMVF PMSVC PMFVC Set the extended relay 2 output OFF delay time.	0.010s (0.000~60.000s)	RUN

#### F06.4x: Frequency Detection

Parameter (Address)	Name	Content	Factory default (range)	Adjustable properly
F06.40 (0x0628)	Frequency detection value 1	V/F SVC FVC PMVF PMSVC PMFVC Set the frequency detection value 1	2.00Hz (0.00~max frequency)	RUN
F06.41 (0x0629)	Frequency detection amplitude 1	V/F SVC FVC PMVF PMSVC PMFVC Set the frequency detection amplitude 1	1.00Hz (0.00~max frequency)	RUN
F06.42 (0x062A)	Frequency detection value 2	V/F SVC FVC PMVF PMSVC PMFVC Set the frequency detection value 2	2.00Hz (0.00~max frequency)	RUN
F06.43 (0x062B)	Frequency detection range 2	V/F SVC FVC PMVF PMSVC PMFVC Set the frequency detection range 2	1.00Hz (0.00~max frequency)	RUN
F06.44 (0x062C)	The given frequency reaches the detection range	V/F SVC FVC PMVF PMSVC PMFVC Set the given frequency to reach the detection range	2.00Hz (0.00~max frequency)	RUN

#### F06.5x: Monitor parameter comparator output

Parameter (Address)	Name	Content	Factory default (range)	Adjustable properly
F06.50 (0x0632)	Comparator 1 monitor selection	V/F SVC FVC PMVF PMSVC PMFVC Units and Tens digits: Set yy value of the Cxx.yy 00~63 Hundreds and thousands: Set xx value of the Cxx.yy 00~07	0001 (0000 ~ 0763)	RUN
F06.51 (0x0633)	Comparator 1 upper limit	V/F SVC FVC PMVF PMSVC PMFVC Set the upper limit of comparator 1	3000 (0 ~ 65535)	RUN
F06.52 (0x0634)	Comparator 1 lower limit	V/F SVC FVC PMVF PMSVC PMFVC Set the lower limit of comparator 1	0 (0 ~ 65535)	RUN
F06.53 (0x0635)	Comparator 1 bias	V/F SVC FVC PMVF PMSVC PMFVC Set the comparator 1 offset value	0 (0 ~ 1000)	RUN
F06.54 (0x0636)	Action selection when sending CP1	V/F SVC FVC PMVF PMSVC PMFVC 0: Continue running(digital terminal output only); 1: Warning and free stop;2: Warning and continue running; 3: Forced stop	0 (0 ~ 3)	RUN
F06.55 (0x0637)	Comparator 2 monitor selection	V/F SVC FVC PMVF PMSVC PMFVC Units and Tens digits: Set yy value of the Cxx.yy 00~63 Hundreds and thousands: Set xx value of the Cxx.yy 00~07	0002 (0000 ~ 0763)	RUN
F06.56 (0x0638)	Comparator 2 upper limit	V/F SVC FVC PMVF PMSVC PMFVC Set the upper limit of comparator 2	30 (0 ~ 65535)	RUN
F06.57 (0x0639)	Comparator 2 lower limit	V/F SVC FVC PMVF PMSVC PMFVC Set the lower limit of comparator 2	0 (0 ~ 65535)	RUN

F06.58 (0x063A)	Comparator 2 bias	<b>V/F SVC FVC PMVF PMSVC PMFVC</b> Set the comparator 2 offset value	0 (0 ~ 1000)	RUN
F06.59 (0x063B)	Action selection when sending CP2	<b>V/F SVC FVC PMVF PMSVC PMFVC</b> 0: Continue running (digital terminal output only) 1: Warning and free stop 2: Warning and continue to run 3: Forced stop	0 (0 ~ 3)	RUN

**F06.6x: Virtual Input and Output Terminal**

Parameter (Address)	Name	Content	Factory default (range)	Adjustable properly
F06.60 (0x063C)	Virtual vX1 terminal function selection	<b>V/F SVC FVC PMVF PMSVC PMFVC</b> See terminal X function	0 (0 ~ 63)	RUN
F06.61 (0x063D) RUN	Virtual vX2 terminal function selection	<b>V/F SVC FVC PMVF PMSVC PMFVC</b> See terminal X function	0 (0 ~ 63)	RUN
F06.62 (0x063E)	Virtual vX3 terminal function selection	<b>V/F SVC FVC PMVF PMSVC PMFVC</b> See terminal X function	0 (0 ~ 63)	RUN
F06.63 (0x063F)	Virtual vX4 terminal function selection	<b>V/F SVC FVC PMVF PMSVC PMFVC</b> See terminal X function	0 (0 ~ 63)	RUN
F06.64 (0x0640)	vX terminal valid status source	<b>V/F SVC FVC PMVF PMSVC PMFVC</b> 0: Internal connection with virtual vYn 1: Link with physical terminal Xn 2: whether the function code setting is valid? Unit: Virtual vX1 Ten: Virtual vX2 Hundreds place: virtual vX3 thousand: virtual vX4	0000 (0000 ~ 2222)	RUN
F06.65 (0x0641)	Virtual vX terminal function code setting valid status	<b>V/F SVC FVC PMVF PMSVC PMFVC</b> 0: invalid; 1: valid Unit: Virtual vX1 Ten: Virtual vX2 Hundreds place: virtual vX3 thousand: virtual vX4	0000 (0000 ~ 1111)	RUN
F06.66 (0x0642)	Virtual vY1 output selection	<b>V/F SVC FVC PMVF PMSVC PMFVC</b> See Y terminal function for details.	0 (0 ~ 31)	RUN
F06.67 (0x0643)	Virtual vY2 output selection	<b>V/F SVC FVC PMVF PMSVC PMFVC</b> See Y terminal function for details.	0 (0 ~ 31)	RUN
F06.68 (0x0644)	Virtual vY3 output selection	<b>V/F SVC FVC PMVF PMSVC PMFVC</b> See Y terminal function for details.	0 (0 ~ 31)	RUN
F06.69 (0x0645)	Virtual vY4 output selection	<b>V/F SVC FVC PMVF PMSVC PMFVC</b> See Y terminal function for details.	0 (0 ~ 31)	RUN
F06.70 (0x0646)	vY1 output ON delay time	<b>V/F SVC FVC PMVF PMSVC PMFVC</b> Set vY1 output ON delay time	0.010s (0.000 ~ 60.000s)	RUN
F06.71 (0x0647)	vY2 output ON delay time	<b>V/F SVC FVC PMVF PMSVC PMFVC</b> Set vY2 output ON delay time	0.010s (0.000 ~ 60.000s)	RUN
F06.72 (0x0648)	vY3 output ON delay time	<b>V/F SVC FVC PMVF PMSVC PMFVC</b> Set vY3 output ON delay time	0.010s (0.000 ~ 60.000s)	RUN
F06.73 (0x0649)	vY4 output ON delay time	<b>V/F SVC FVC PMVF PMSVC PMFVC</b> Set vY4 output ON delay time	0.010s (0.000 ~ 60.000s)	RUN
F06.74 (0x064A)	vY1 output OFF delay time	<b>V/F SVC FVC PMVF PMSVC PMFVC</b> Set vY1 output OFF delay time	0.010s (0.000 ~ 60.000s)	RUN
F06.75 (0x064B)	vY2 output OFF delay time	<b>V/F SVC FVC PMVF PMSVC PMFVC</b> Set vY2 output OFF delay time	0.010s (0.000 ~ 60.000s)	RUN
F06.76 (0x064C)	vY3 output OFF delay time	<b>V/F SVC FVC PMVF PMSVC PMFVC</b> Set vY3 output OFF delay time	0.010s (0.000 ~ 60.000s)	RUN
F06.77 (0x064D)	vY4 output OFF delay time	<b>V/F SVC FVC PMVF PMSVC PMFVC</b> Set vY4 output OFF delay time	0.010s (0.000 ~ 60.000s)	RUN

## 4.10 F07 : Operational Control

Parameter (Address)	Name	Content	Factory default (range)	Adjustable properly
F07.00 (0x0700)	Start mode	V/F SVC FVC PMVF PMSVC PMFVC 0: started by the start frequency 1: DC braking first starts again from the starting frequency 2: Start after the speed tracking and direction judgment	0 (0~2)	STOP
F07.01 (0x0701)	Start pre-excitation time	V/F SVC FVC PMVF PMSVC PMFV Only asynchronous machine vector control (without PG) supports pre-excitation, other ignore	0.00s (0.00~60.00s)	STOP
F07.02 (0x0702)	Starting frequency	V/F SVC FVC PMVF PMSVC PMFVC When the given frequency is less than this value, it does not start and is in standby state	0.50Hz (0.00~upper limit frequency setting)	STOP
F07.03 (0x0703)	Start protection selection	V/F SVC FVC PMVF PMSVC PMFVC 0: off 1: on Unit: terminal start protection when exiting abnormal Tens: Jog terminal start protection when exiting abnormal Hundreds: terminal start protection when the command channel is switched to the terminal Note: When the free stop, emergency stop, and forced stop commands are valid, the terminal start protection is enabled by default, and the protection time is reported as A.RUNx warning.	0111 (0000~1111)	STOP
F07.05 (0x0705)	Direction of rotation	V/F SVC FVC PMVF PMSVC PMFVC Unit: running direction 0: Direction unchanged 1: Direction reversed Tens: running direction selection 0: allow Fwd and Rev commands 1: Fwd command only 2: Rev command only Hundreds: Frequency control command 0: command is invalid 1: command is valid	0000 (0000~1121)	STOP
F07.06 (0x0706)	Power failure restart action selection	V/F SVC FVC PMVF PMSVC PMFVC 0: Invalid 1: Valid	0 (0~1)	STOP
F07.07 (0x0707)	Power failure restart waiting time	V/F SVC FVC PMVF PMSVC PMFVC Set the power failure restart waiting time	0.50s (0.00~60.00s)	STOP

### F07.1x: Stop Control

Parameter (Address)	Name	Content	Factory default (range)	Adjustable properly
F07.10 (0x070A)	Stop mode	V/F SVC FVC PMVF PMSVC PMFVC 0: Deceleration stop 1: Free stop	0 (0~1)	RUN
F07.11 (0x070B)	Shutdown detection frequency	V/F SVC FVC PMVF PMSVC PMFVC When decelerating to stop, when the inverter output frequency is less than this value, it will enter the stop state.	0.50Hz (0.00~upper limit frequency setting)	RUN
F07.12 (0x070C)	Stop and restart limit time	V/F SVC FVC PMVF PMSVC PMFVC Waiting time after restarting after shutdown	0.00s (0.00~60.00s)	STOP
F07.15 (0x070F)	Insufficient lower limit frequency action selection	V/F SVC FVC PMVF PMSVC PMFVC 0: Run according to frequency command 1: Free running stops, enters the pause state 2: Run at the following limited frequency 3: Zero speed operation	0 (0~3)	RUN
F07.16 (0x0710)	Zero speed torque retention factor	V/F SVC FVC PMVF PMSVC PMFVC Set zero speed torque current, 100.0% corresponds to inverter rated current	60.0% (0.0~150.0%)	RUN
F07.17 (0x0711)	Zero speed torque holding time	V/F SVC FVC PMVF PMSVC PMFVC Set zero speed torque hold time	0.0s (0.0~6000.0s)	RUN
F07.18 (0x0712)	Positive reversal dead time	V/F SVC FVC PMVF PMSVC PMFVC Fwd and Rev switching, zero frequency maintenance time	0.0s (0.0~120.0s)	STOP

### F07.2x: DC Braking and Speed Tracking

Parameter (Address)	Name	Content	Factory default (range)	Adjustable properly
---------------------	------	---------	-------------------------	---------------------



F07.20 (0x0714)	Braking current before starting	V/F SVC FVC PMVF PMSVC PMFVC Set the brake current before starting	60.0% (0.0~150.0%)	STOP
F07.21 (0x0715)	Braking time before starting	V/F SVC FVC PMVF PMSVC PMFVC Set the brake time before starting	0.0s (0.0~60.0s)	STOP
F07.22 (0x0716)	DC braking start frequency	V/F SVC FVC PMVF PMSVC PMFVC Set the DC brake start frequency	1.00Hz (0.00~50.00Hz)	STOP
F07.23 (0x0717)	DC braking current	V/F SVC FVC PMVF PMSVC PMFVC Refer to rated current, because the internal limit current cannot exceed the rated current	60.0% (0.0~150.0%)	STOP
F07.24 (0x0718)	DC braking time during stopping	V/F SVC FVC PMVF PMSVC PMFVC Set the DC braking time during stopping	0.0s (0.0~60.0s)	STOP
F07.25 (0x0719)	Speed tracking mode	V/F SVC FVC PMVF PMSVC PMFVC Units: Search method 0: Search from the maximum frequency 1: Search from the stop frequency Tens: Reverse search 0: Off 1: On Hundreds: Search source 0: Software search 1: Hardware search	0000 (0000~1111)	STOP
F07.26 (0x071A)	Speed tracking speed	V/F SVC FVC PMVF PMSVC PMFVC Set the speed of tracking speed	0.5s (0.0~60.0s)	STOP
F07.27 (0x071B)	Speed tracking stop delay	V/F SVC FVC PMVF PMSVC PMFVC Set speed tracking stop delay	1.00s (0.0~60.0s)	STOP
F07.28 (0x071C)	Speed tracking current	V/F SVC FVC PMVF PMSVC PMFVC Set speed tracking current	120.0% (0.0~400.0%)	STOP

**F07.3x: Jog**

Parameter (Address)	Name	Content	Factory default (range)	Adjustable properly
F07.30 (0x071E)	Jog running frequency setting	V/F SVC FVC PMVF PMSVC PMFVC Set jog running frequency	5.00Hz (0.00~Max frequency)	RUN
F07.31 (0x071F)	Jog acceleration time	V/F SVC FVC PMVF PMSVC PMFVC Set jog acceleration time	10.0s (0.0~650.0s)	RUN
F07.32 (0x0720)	Jog deceleration time	V/F SVC FVC PMVF PMSVC PMFVC Set jog deceleration time	10.0s (0.0~650.0s)	RUN
F07.33 (0x0721)	Jog S curve selection	V/F SVC FVC PMVF PMSVC PMFVC 0: Invalid 1: Valid	0 (0~1)	RUN
F07.34 (0x0722)	Jog stop mode selection	V/F SVC FVC PMVF PMSVC PMFVC Set stop mode 0: According to F7.10 setting mode 1: Deceleration only	0 (0~1)	STOP

**F07.4x: Startup, Stopping Frequency Maintenance and Jump Frequency**

Parameter (Address)	Name	Content	Factory default (range)	Adjustable properly
F07.40 (0x0728)	Maintain frequency at startup	V/F SVC FVC PMVF PMSVC PMFVC Startup maintenance frequency is greater than the start frequency, less than the upper limit set frequency	0.50Hz (0.00~Upper limit frequency)	STOP
F07.41 (0x0729)	Maintain frequency time at startup	V/F SVC FVC PMVF PMSVC PMFVC The value should be higher than the start frequency, and when it is lower, according to start frequency	0.0s (0.0~60.0s)	STOP
F07.42 (0x072A)	Maintain frequency during stop	V/F SVC FVC PMVF PMSVC PMFVC Set the maintain frequency during stop	0.50Hz (0.00~Upper limit frequency)	STOP
F07.43 (0x072B)	Maintain frequency time during stop	V/F SVC FVC PMVF PMSVC PMFVC Set the time of stop maintain frequency	0.0s (0.0~60.0s)	STOP
F07.44 (0x072C)	Jump frequency 1	V/F SVC FVC PMVF PMSVC PMFVC Set the jump frequency 1	0.00Hz (0.00~Max frequency)	RUN
F07.45 (0x072D)	Jump frequency 1 amplitude	V/F SVC FVC PMVF PMSVC PMFVC Set the amplitude of jump frequency 1	0.00Hz	RUN

			(0.00~Max frequency)	
F07.46 (0x072E)	Jump frequency 2	V/F SVC FVC PMVF PMSVC PMFVC Set the jump frequency 2	0.00Hz (0.00~Max frequency)	RUN
F07.47 (0x072F)	Jump frequency 2 amplitude	V/F SVC FVC PMVF PMSVC PMFVC Set the amplitude of jump frequency 2	0.00Hz (0.00~Max frequency)	RUN

## 4.11 F08: Auxiliary Control

Parameter (Address)	Name	Content	Factory default (range)	Adjustable properly
F08.00 (0x0800)	Counter input source	V/F SVC FVC PMVF PMSVC PMFVC 0: normal X terminal 1: input PUL terminal 2-5: reserved	0 (0~5)	RUN
F08.01 (0x0801)	Count input frequency division	V/F SVC FVC PMVF PMSVC PMFVC Set the input frequency division of the counter	0 (0~6000)	RUN
F08.02 (0x0802)	Counter maximum	V/F SVC FVC PMVF PMSVC PMFVC Set the max value of the counter	1000 (0~65000)	RUN
F08.03 (0x0803)	Counter setting	V/F SVC FVC PMVF PMSVC PMFVC Counter setting	500 (0~65000)	RUN
F08.04 (0x0804)	Pulse number per meter	V/F SVC FVC PMVF PMSVC PMFVC Set the counter value for per meter	10.0 (0.1~6500.0)	RUN
F08.05 (0x0805)	Set length	V/F SVC FVC PMVF PMSVC PMFVC Set length	1000 (0~65000M)	STOP
F08.06 (0x0806)	Actual length	V/F SVC FVC PMVF PMSVC PMFVC Set the actual length	0 (0~65000M)	STOP
F08.07 (0x0807)	Timer time unit	V/F SVC FVC PMVF PMSVC PMFVC Unit of the timer 0: Second 1: Minute 2: Hour	0 (0~2)	STOP
F08.08 (0x0808)	Timer setting	V/F SVC FVC PMVF PMSVC PMFVC Set the timer setting	0 (0~65000)	STOP

### F08.3x: Swing Frequency Control

Parameter (Address)	Name	Content	Factory default (range)	Adjustable properly
F08.30 (0x081E)	Swing frequency control	V/F SVC FVC PMVF PMSVC PMFVC 0: Swing frequency control is invalid 1: Swing frequency control is valid	0 (0~1)	STOP
F08.31 (0x081F)	Swing frequency amplitude control	V/F SVC FVC PMVF PMSVC PMFVC Unit: Start Mode 0: Automatically 1: Terminal manual Tens: Swing amplitude control 0: Relative center frequency 1:Relative maximum frequency. Hundreds: preset frequency enable 0: not enabled 1: enabled	0000 (0000~0111)	STOP
yF08.32 (0x0820)	Swing frequency preset frequency	V/F SVC FVC PMVF PMSVC PMFVC Set the swing frequency preset frequency	0.00Hz (0~upper limit frequency)	STOP
F08.33 (0x0821)	Swing frequency preset frequency waiting time	V/F SVC FVC PMVF PMSVC PMFVC Set the swing frequency preset frequency waiting time	0.0s (0.0~3600.0s)	STOP
F08.34 (0x0822)	Swing frequency amplitude	V/F SVC FVC PMVF PMSVC PMFVC Set the swing frequency amplitude	10.0% (0.0~50.0%)	STOP
F08.35 (0x0823)	Kick frequency	V/F SVC FVC PMVF PMSVC PMFVC Set the kick frequency	10.0% (0.0~50.0%)	STOP
F08.36 (0x0824)	Triangle wave rise time	V/F SVC FVC PMVF PMSVC PMFVC Set the triangle wave rise time	5.00s (0.1~999.9s)	STOP
F08.37 (0x0825)	Triangle wave fall time	V/F SVC FVC PMVF PMSVC PMFVC Set the triangle wave fall time	5.00s (0.0~100.0s)	STOP

## 4.12 F09: Reserved

## 4.13 F10: Protection Parameter

Parameter (Address)	Name	Content	Factory default (range)	Adjustable properly
F10.00 (0x0A00)	Overcurrent suppression	<b>V/F SVC FVC PMVF PMSVC PMFVC</b> Automatically limit the output current cannot exceed the overcurrent suppression point to prevent overcurrent faults 0: Suppression is always valid 1: Acceleration/deceleration is valid, constant speed is invalid	0 (0 ~ 1)	RUN
F10.01 (0x0A01)	Overcurrent suppression point	<b>V/F SVC FVC PMVF PMSVC PMFVC</b> Set the load current limit level, the value 100% corresponds to the rated motor current.	160.0% (0.0 ~ 300.0%)	RUN
F10.02 (0x0A02)	Overcurrent suppression gain	<b>V/F SVC FVC PMVF PMSVC PMFVC</b> Set the response effect of overcurrent suppression.	100.0% (0.0 ~ 500.0%)	RUN
F10.03 (0x0A03)	Current protection setting 1	<b>V/F SVC FVC PMVF PMSVC PMFVC</b> Set whether current-related protection is enabled Unit: Wave-by-wave current limit (CBC) 0: off 1: on Tens: OC protection interference suppression 0: Normal 1: Primary interference suppression 2: Secondary interference suppression Hundreds: SC protection interference suppression 0: Normal 1: Primary interference suppression 2: Secondary interference suppression	0001 (0000~0221)	STOP
F10.04 (0x0A04)	Current protection setting 2	<b>V/F SVC FVC PMVF PMSVC PMFVC</b> Unit position: three-phase current and protection options 0: off 1: On	0001 (0000~0001)	STOP

### F10.1x: Voltage Protection

Parameter (Address)	Name	Content	Factory default (range)	Adjustable properly
F10.10 (0x0A0A)	Bus overvoltage hardware protection	<b>V/F SVC FVC PMVF PMSVC PMFVC</b> Set whether the bus overvoltage hardware protection function is enabled. 0: off 1: on	0 (0 ~ 1)	STOP
F10.11 (0x0A0B)	Bus overvoltage suppression	<b>V/F SVC FVC PMVF PMSVC PMFVC</b> When the bus voltage is greater than the overvoltage suppression point, it will slow down or stop the acceleration and deceleration to prevent overvoltage faults. Unit: Overvoltage suppression function 0: Off 1: Only enable during deceleration 2: Enable during both acceleration and deceleration Tens: overexcitation function 0: off 1: on	0012 (0000~0012)	STOP
F10.12 (0x0A0C)	Bus overvoltage suppression point	<b>V/F SVC FVC PMVF PMSVC PMFVC</b> Set bus voltage value for trigger overvoltage suppression function	T3: 780 S2: 365 (0~ overvoltage point) T3 overvoltage point:820V;S2 overvoltage point:390V	STOP
F10.13 (0x0A0D)	Bus overvoltage suppression gain	<b>V/F SVC FVC PMVF PMSVC PMFVC</b> Set the response effect of overvoltage suppression	100.0% (0.0~500.0%)	RUN
F10.14 (0x0A0E)	Energy brake enable	<b>V/F SVC FVC PMVF PMSVC PMFVC</b> Set whether the energy brake function is on 0: Off 1: On, but off overvoltage suppression 2: Turn on, and turn on the overvoltage suppression function.	2 (0~2)	RUN

F10.15 (0x0A0F)	Energy consuming braking action voltage	<b>V/F SVC FVC PMVF PMSVC PMFVC</b> Set the energy consuming braking action voltage, when the bus voltage is greater than this value, the energy consuming brake starts to act	T3: 735 S2: 360 (0~ overvoltage point) T3 overvoltage point:820V;S2 overvoltage point:390V	RUN
F10.16 (0x0A10)	Bus undervoltage suppression	<b>V/F SVC FVC PMVF PMSVC PMFVC</b> When the bus voltage is lower than the undervoltage suppression point, the operating frequency is automatically adjusted to suppress the bus voltage from decreasing, preventing the undervoltage fault. 0: off 1: on	0 (0~1)	STOP
F10.17 (0x0A11)	Bus undervoltage suppression point	<b>V/F SVC FVC PMVF PMSVC PMFVC</b> Set bus voltage value for trigger undervoltage suppression function	T3: 430 S2: 240 (0~ overvoltage point) T3 overvoltage point:820V;S2 overvoltage point:390V	STOP
F10.18 (0x0A12)	Bus undervoltage suppression gain	<b>V/F SVC FVC PMVF PMSVC PMFVC</b> Set the response effect of undervoltage suppression	100.0% (0.0~500.0%)	RUN
F10.19 (0x0A13)	Bus undervoltage protection point	<b>V/F SVC FVC PMVF PMSVC PMFVC</b> Set the allowable lower limit of the bus voltage. Below this value, the inverter reports undervoltage fault.	T3: 350 S2: 190 (0~ overvoltage point) T3 overvoltage point:820V;S2 overvoltage point:390V	STOP

**F10.2x: Auxiliary Protection**

Parameter (Address)	Name	Content	Factory default (range)	Adjustable properly
F10.20 (0x0A14)	Input and output phase loss protection options	<b>V/F SVC FVC PMVF PMSVC PMFVC</b> Set whether the input and output phase loss protection functions are enabled. Unit: Output phase loss protection 0: off 1: on Tens: input phase loss protection 0: off 1: On, when detect the input loss phase report warning A.I.LF, continue to run 2: On, when detect input loss phase report fault E.I.LF, free stop	0021 (000~0121)	STOP
F10.21 (0x0A15)	Input phase loss threshold	<b>V/F SVC FVC PMVF PMSVC PMFVC</b> Set the percentage of voltage detection of the input phase loss detection function, 100% corresponds to the rated bus voltage	10% (0~30.0%)	STOP
F10.22 (0x0A16)	Ground short circuit protection option	<b>V/F SVC FVC PMVF PMSVC PMFVC</b> Set whether the inverter output and the inverter cooling fan ground short circuit protection function are enabled. Unit: Output short circuit protection 0: off 1: on Tens: fan to ground short circuit protection 0: off 1: on	0011 (0000~0012)	STOP
F10.23 (0x0A17)	Fan ON/OFF control selection	<b>V/F SVC FVC PMVF PMSVC PMFVC</b> Set the inverter cooling fan operation mode 0: The fan runs after the inverter is powered on. 1: After the shutdown, the fan operation is related to temperature, and the operation is running. 2: After the shutdown, the fan stops after F10.24, and the operation is related to temperature.	1 (0~2)	RUN
F10.24 (0x0A18)	Fan control delay time	<b>V/F SVC FVC PMVF PMSVC PMFVC</b> Set the time from shutdown to the cooling fan stops running	30.00s (0~600.00)	STOP
F10.25 (0x0A19)	Inverter overheating oH1 warning detection level	<b>V/F SVC FVC PMVF PMSVC PMFVC</b> Set the temperature value of the inverter overheat warning, which is higher than the value to report the overheat warning.	80.0℃ (0~100.0)	RUN

## F10.3x: Load Protection

Parameter (Address)	Name	Content	Factory default (range)	Adjustable properly
F10.30 (0x0A1E)	Motor overload protection curve coefficient	<b>V/F SVC FVC PMVF PMSVC PMFVC</b> Set the coefficient of overload protection for the load motor. Increasing this value can increase the overload capacity of the motor.	100.0% (0~250.0%)	STOP
F10.31 (0x0A1F)	Selection of inverter overload characteristics at low speed	<b>V/F SVC FVC PMVF PMSVC PMFVC</b> Set whether the overload protection function is valid when the speed is low (less than 5Hz)	0 (0~1)	STOP
F10.32 (0x0A20)	Load warning checkout setting	<b>V/F SVC FVC PMVF PMSVC PMFVC</b> Set the inverter load warning detection mode and the early warning mode at this time Unit: Load warning checkout 1 setting 0: No detection 1: The detection load is too large 2: Excessive load detection only at constant speed 3: Insufficient detection load 4: Insufficient load detection only at constant speed Ten digits: warning setting when load warning is detected 1 0: continue to run, report.ALD1 1: Free stop, report to E.LD1 Hundreds place: load warning checkout 2 setting 0: No detection 1: The detection load is too large 2: Excessive load detection only at constant speed 3: Insufficient detection load 4: Insufficient load detection only at constant speed Thousands: warning setting when load warning is detected 2 0: continue to run, report.ALD1 1: Free stop, report to E.LD1	0000 (0000~1414)	STOP
F10.33 (0x0A21)	Load warning detection level 1	<b>V/F SVC FVC PMVF PMSVC PMFVC</b> Set the detection value of load warning 1 Under VF control, this value 100% is corresponding to the rated current of the motor. Under vector control, this value 100% is corresponding to the rated output torque of the motor.	130.0% (0~200.0%)	STOP
F10.34 (0x0A22)	Load warning detection time 1	<b>V/F SVC FVC PMVF PMSVC PMFVC</b> Set the duration of the detected load warning 1 and the load is greater than the load warning detection level for the duration, and the load warning 1 is reported.	5.0s (0~60.0)	STOP
F10.35 (0x0A23)	Load warning detection level 2	<b>V/F SVC FVC PMVF PMSVC PMFVC</b> Set the detection value of load warning 1 Under VF control, this value 100% is corresponding to the rated current of the motor. Under vector control, this value 100% is corresponding to the rated output torque of the motor.	130.0% (0~200.0%)	STOP
F10.36 (0x0A24)	Load warning detection time 2	<b>V/F SVC FVC PMVF PMSVC PMFVC</b> Set the duration of the detected load warning 2 and the load is greater than the load warning detection level for the duration, and the load warning 2 is reported.	5.0s (0~60.0)	STOP

## F10.4x: Stall Protection

Parameter (Address)	Name	Content	Factory default (range)	Adjustable properly
F10.40 (0x0A28)	Speed deviation excessive protection action	<b>V/F SVC FVC PMVF PMSVC PMFVC</b> Set the warning detection mode selection and alarm mode selection when deviation between the motor given speed and feedback speed is excessive Unit: Check out the selection 0: No detection 1: Only at constant speed detection 2: Always detected Ten places: alarm selection 0: Free stop and report fault 1: Alarm and continue to run	0000 (0000~0012)	STOP
F10.41 (0x0A29)	Speed deviation excessive detection threshold	<b>V/F SVC FVC PMVF PMSVC PMFVC</b> Set the detected value when speed deviation is excessive. This value corresponds to F01.10 [maximum frequency].	10.0% (0~60.0%)	STOP

F10.42 (0x0A2A)	Speed deviation excessive detection time	<b>V/F SVC FVC PMVF PMSVC PMFVC</b> Set the detection time of the excessive speed deviation, when the speed deviation is excessive and the duration is longer than this time value the deviation warning reported	2s (0~60)	STOP
F10.43 (0x0A2B)	Speed protection action	<b>V/F SVC FVC PMVF PMSVC PMFVC</b> Set the alarm detection mode selection and alarm mode selection when the motor is overspeed Unit: Check out the selection 0: No detection 1: Only at constant speed detection 2: Always detected Ten places: alarm selection 0: Free stop and report fault 1: Alarm and continue to run	0002 (0000~0012)	STOP
F10.44 (0x0A2C)	Speed exceed detection threshold	<b>V/F SVC FVC PMVF PMSVC PMFVC</b> Set the speed exceed warning detection value, which corresponds to F01.10 [maximum frequency]	110.0% (0~150.0%)	STOP
F10.45 (0x0A2D)	Speed exceed detection time	<b>V/F SVC FVC PMVF PMSVC PMFVC</b> Set the duration of the detection of the flying speed, the feedback speed is greater than F10.44 and continue for that time, and the speed warning is detected.	0.010s (0~2.000)	STOP

### F10.5x: Fault Recovery Protection

Parameter (Address)	Name	Content	Factory default (range)	Adjustable properly
F10.50 (0x0A32)	Fault self-recovery	<b>V/F SVC FVC PMVF PMSVC PMFVC</b> Set the allowable times of fault self-recovery. Note: the value of 0 indicate the function is turn off otherwise the function is enable	0 (0~10)	STOP
F10.51 (0x0A33)	Fault self-recovery interval	<b>V/F SVC FVC PMVF PMSVC PMFVC</b> Set the waiting time from fault to reset	1.0s (0~100.0)	STOP
F10.52 (0x0A34)	Number of fault recovered	<b>V/F SVC FVC PMVF PMSVC PMFVC</b> This value indicates the number of self-recovery that have been performed. This parameter is a read-only parameter.	0	READ

## 4.14 F11: Operator Parameter

### F11.0x: Button Operation

Parameter (Address)	Name	Content	Factory default (range)	Adjustable properly
F11.00 (0x0B00)	Key lock selection	<b>V/F SVC FVC PMVF PMSVC PMFVC</b> 0: No lock 1: Keyboard function parameter modification lock 2: Function parameters and non-start and stop button lock 3: function parameters and button full lock	0 (0~3)	RUN
F11.01 (0x0B01)	Key lock password	<b>V/F SVC FVC PMVF PMSVC PMFVC</b> Set the key lock password	0 (0~65535)	RUN
F11.02 (0x0B02)	Keyboard multi-function key selection	<b>V/F SVC FVC PMVF PMSVC PMFVC</b> 0: Invalid 1: Reverse run key 2: Forward jog run key 3: Reverse jog run key 4: Keyboard command channel and terminal naming channel switch 5: Keyboard command channel and communication naming channel switch 6: Terminal command channel and communication naming channel switch 7: keyboard, terminal, communication command channel cycle switching	0 (0~7)	STOP
F11.03 (0x0B03)	Keyboard STOP button settings	<b>V/F SVC FVC PMVF PMSVC PMFVC</b> 0: Non-keyboard control mode is invalid 1: Non-keyboard control mode stops according to stop mode 2: Non-keyboard control mode stops in free mode	0 (0~2)	STOP
F11.04 (0x0B04)	Status interface up and down keys (knob) function selection	<b>V/F SVC FVC PMVF PMSVC PMFVC</b> Unit keyboard up and down keys to modify the selection 0: Invalid 1: Used to adjust the frequency keyboard given F01.09 2: used to adjust the PID keyboard given F13.01 3: Keyboard up and down keys to modify the parameter number	0011 (0000~0213)	STOP

		setting Ten place: power down storage 0: frequency power down is not stored 1: frequency power down storage Hundreds: Action Limit 0: Run stop adjustable 1: Only adjustable during operation, stop and keep 2: Adjustable during operation, stop and clear		
F11.05 (0x0B05)	Up and down keys to quickly change the parameter code setting	<b>V/F SVC FVC PMVF PMSVC PMFVC</b> Ten digits: yy setting in function parameter number Fxx.yy 00~99 Hundreds of thousands: xx setting in function parameter number Fxx.yy 00~15	0109 (0000 ~ 1563)	RUN
F11.06 (0x0B06)	Keyboard command key selection	<b>V/F SVC FVC PMVF PMSVC PMFVC</b> Units: Built-in, external keyboard button commands (run command, stop/reset command) 0: External priority, when the external is valid, the built-in is invalid. 1: Built-in priority, when the built-in is valid, the external is invalid 2: Both internal and external are valid, the stop/reset command takes precedence; when the forward and reverse are valid at the same time, it is used as the stop command.	0000 (0000 ~ 1122)	STOP

### F11.1x: Status Interface Cyclic Monitoring

Parameter (Address)	Name	Content	Factory default (range)	Adjustable properly
F11.10 (0x0B0A)	Status interface left shift, right shift key function selection	<b>V/F SVC FVC PMVF PMSVC PMFVC</b> Unit: left shift key to adjust the first line of monitoring 0: Invalid 1: Valid Tens: right shift key to adjust the second line of monitoring 0: Invalid 1: Valid When the left/right shift key is invalid, the monitor display value is displayed as parameter 1 after power-on.	0011 (0000 ~ 0011)	STOP
F11.11 (0x0B0B)	The first line of the keyboard shows the parameter 1	<b>V/F SVC FVC PMVF PMSVC PMFVC</b> Ten digits: yy setting in monitoring parameter number Cxx.yy 00~63 Hundreds of thousands: monitoring parameter number Cxx.yy xx setting 00~07	0000 (0000 ~ 0763)	RUN
F11.12 (0x0B0C)	The first line of the keyboard shows the parameter 2	<b>V/F SVC FVC PMVF PMSVC PMFVC</b> Ditto	0001 (0000 ~ 0763)	RUN
F11.13 (0x0B0D)	The first line of the keyboard shows the parameter 3	<b>V/F SVC FVC PMVF PMSVC PMFVC</b> Ditto	0002 (0000 ~ 0763)	RUN
F11.14 (0x0B0E)	The first line of the keyboard shows the parameter 4	<b>V/F SVC FVC PMVF PMSVC PMFVC</b> Ditto	0011 (0000 ~ 0763)	RUN
F11.15 (0x0B0F)	The second line of the keyboard shows the parameter 1	<b>V/F SVC FVC PMVF PMSVC PMFVC</b> Ditto	0002 (0000 ~ 0763)	RUN
F11.16 (0x0B10)	The second line of the keyboard shows the parameter 2	<b>V/F SVC FVC PMVF PMSVC PMFVC</b> Ditto	0004 (0000 ~ 0763)	RUN
F11.17 (0x0B11)	The second line of the keyboard shows the parameter 3	<b>V/F SVC FVC PMVF PMSVC PMFVC</b> Ditto	0010 (0000 ~ 0763)	RUN
F11.18 (0x0B12)	The second line of the keyboard shows the parameter 4	<b>V/F SVC FVC PMVF PMSVC PMFVC</b> Ditto	0012 (0000 ~ 0763)	RUN

**F11.2x: Monitoring Parameter**

Parameter (Address)	Name	Content	Factory default (range)	Adjustable properly
F11.20 (0x0B14)	Keyboard display item settings	<b>V/F SVC FVC PMVF PMSVC PMFVC</b> Unit digit: Output frequency display selection 0: Target frequency 1: Operating frequency >=2: Target frequency, the filtering depth increases with this value Ten: reserved Hundreds: Power Display Dimensions 0: Power display percentage (%) 1: Power display kilowatt (KW) Thousands: reserved	0002 (0000 ~ 111F)	RUN
F11.21 (0x0B15)	Speed display factor	<b>V/F SVC FVC PMVF PMSVC PMFVC</b> Adjust the speed display of C00.06.	100.0% (0.0 ~ 500.0%)	RUN
F11.22 (0x0B16)	Power display factor	<b>V/F SVC FVC PMVF PMSVC PMFVC</b> Adjust the output power display of C00.10.	100.0% (0.0 ~ 500.0%)	RUN
F11.23 (0x0B17)	Monitoring parameter group display selection	<b>V/F SVC FVC PMVF PMSVC PMFVC</b> Unit: Reserved Ten: C05 display selection 0: Automatically switch according to the control mode 1: V/F mode related parameters 2: VC mode related parameters Hundreds place: C00.40~C00.63 display selection 0: Do not display 1: display Thousands: Communication fault code switching enable 0: not enabled 1: Enable, the fault code is switched to the same as RD11 when 485 communication 2: Enable, the fault code is switched to the AC70 when 485 communication	0000 (0000 ~ FFFF)	RUN
F11.24 (0x0B18)	Monitoring parameter filtering selection	<b>V/F SVC FVC PMVF PMSVC PMFVC</b> Unit: Output current display filter 0-F: the larger the value, the deeper the filter	0002 (0000 ~ 000F)	RUN
F11.25 (0x0B19)	Display selection when the motor is self-learning	<b>V/F SVC FVC PMVF PMSVC PMFVC</b> Set the display selection when the motor is self-learning 0: Display self-learning process status 1: Do not display self-learning process status	0 (0 ~ 1)	STOP
F11.27 (0x0B1B)	Fault display selection	<b>V/F SVC FVC PMVF PMSVC PMFVC</b> Unit: The fault is displayed when the fault recovers. 0: Do not display 1: Display	0001 (0000 ~ 0001)	RUN

**4.15 F12: Communication Parameter****F12.0x: MODBUS Slave Parameter**

Parameter (Address)	Name	Content	Factory default (range)	Adjustable properly
F12.00 (0x0C00)	Host-slave choice	<b>V/F SVC FVC PMVF PMSVC PMFVC</b> 0: Slave, 1: Host	0 (0 ~ 1)	STOP
F12.01 (0x0C01)	Modbus communication address	<b>V/F SVC FVC PMVF PMSVC PMFVC</b> Set different values for different slaves.	1 (1 ~ 247)	STOP
F12.02 (0x0C02)	Communication baud rate selection	<b>V/F SVC FVC PMVF PMSVC PMFVC</b> 0: 1200 bps 1: 2400 bps 2: 4800 bps 3: 9600 bps 4: 19200 bps 5: 38400 bps 6: 57600 bps	3 (0 ~ 6)	STOP
F12.03 (0x0C03)	Modbus data format	<b>V/F SVC FVC PMVF PMSVC PMFVC</b> 0: (N, 8, 1) no parity, data bits: 8, stop bits: 1 1: (E, 8, 1) even parity, data bits: 8, stop bits: 1 2: (O, 8, 1) odd parity, data bits: 8, stop bits: 1 3: (N, 8, 2) no parity, data bits: 8, stop bits: 2 4: (E, 8, 2) even parity, data bits: 8, stop bits: 2 5: (O, 8, 2) odd parity, data bits: 8, stop bits: 2	0 (0 ~ 5)	STOP



F12.04 (0x0C04)	Modbus transmission response processing	V/F SVC FVC PMVF PMSVC PMFVC 0: Write operation has a response 1: Write operation has no response	0 (0 ~ 1)	RUN
F12.05 (0x0C05)	Modbus communication response delay	V/F SVC FVC PMVF PMSVC PMFVC Set the time of Modbus communication response delay	0ms (0 ~ 500ms)	RUN
F12.06 (0x0C06)	Modbus communication timeout failure time	V/F SVC FVC PMVF PMSVC PMFVC Set the time of Modbus communication timeout failure	1.0s (0.1 ~ 100.0s)	RUN
F12.07 (0x0C07)	Communication disconnection processing	V/F SVC FVC PMVF PMSVC PMFVC 0: Do not detect timeout failure 1: Fault and free stop 2: Warning and continue to run 3: Forced stop	0 (0 ~ 3)	RUN
F12.08 (0x0C08)	Receive data (address 0x3000) zero bias	V/F SVC FVC PMVF PMSVC PMFVC Offset correction communication data for address 0x3000.	0.00 (-100.00~100.00)	RUN
F12.09 (0x0C09)	Receive data (address 0x3000) gain	V/F SVC FVC PMVF PMSVC PMFVC Linearly correct communication data of the address 0x3000.	100.0% (0.0~500.0%)	RUN

**F12.1x: MODBUS Host Parameter**

Parameter (Address)	Name	Content	Factory default (range)	Adjustable properly
F12.10 (0x0C0A)	Host cyclically send parameter selection	V/F SVC FVC PMVF PMSVC PMFVC 0: Invalid 1: Host run command 2: host given frequency 3: host output frequency 4: Host upper limit frequency 5: Host given torque 6: Host output torque 7: Reserved 8: Reserved 9: Host PID given A: Host PID feedback B: Reserved C: active current component	0031 (0000 ~ CCCC)	RUN
F12.11 (0x0C0B)	Frequency given custom address setting	V/F SVC FVC PMVF PMSVC PMFVC Set frequency given custom address	0000 (0000 ~ FFFF)	RUN
F12.12 (0x0C0C)	Command given custom address settings	V/F SVC FVC PMVF PMSVC PMFVC Set command to give a custom address	0000 (0000 ~ FFFF)	RUN
F12.13 (0x0C0D)	Command given as forward run command value	V/F SVC FVC PMVF PMSVC PMFVC The set command is given as the forward run command value.	0001 (0000 ~ FFFF)	RUN
F12.14 (0x0C0E)	Command given as reverse run command value	V/F SVC FVC PMVF PMSVC PMFVC The set command is given as the reverse run command value.	0002 (0000 ~ FFFF)	RUN
F12.15 (0x0C0F)	Command given as stop command value	V/F SVC FVC PMVF PMSVC PMFVC The set command is given as the stop command value.	0005 (0000 ~ FFFF)	RUN
F12.16 (0x0C10)	Command given as reset command value	V/F SVC FVC PMVF PMSVC PMFVC Set command as reset command value	0007 (0000 ~ FFFF)	RUN

**F12.3x: Profibus-DP**

Parameter (Address)	Name	Content	Factory default (range)	Adjustable properly
F12.30 (0x0C1E)	DP card address	V/F SVC FVC PMVF PMSVC PMFVC Set the address of DP card	1 (1 ~ 247)	RUN

**F12.4x: CAN Mode**

Parameter (Address)	Name	Content	Factory default (range)	Adjustable properly
F12.40 (0x0C28)	CAN mode selection	V/F SVC FVC PMVF PMSVC PMFVC 0: Slave 1: Host station of VEDA-in	1 (0 ~ 1)	RUN
F12.41 (0x0C29)	Communication address	V/F SVC FVC PMVF PMSVC PMFVC Set the address of the slave	1 (1 ~ 247)	RUN
F12.42 (0x0C2A)	Communication baud rate selection	V/F SVC FVC PMVF PMSVC PMFVC 0: 20 kbps 1: 50 kbps 2: 100kbps 3: 125kbps 4: 250kbps 5: 500kbps	3 (0 ~ 6)	RUN

		6: 1Mbps		
--	--	----------	--	--

### F12.5x: EX-A,EX-B Communication

Parameter (Address)	Name	Content	Factory default (range)	Adjustable properly
F12.50 (0x0C32)	Expansion port communication disconnection processing	<b>V/F SVC FVC PMVF PMSVC PMFVC</b> Unit: EX-A port disconnection action mode 0: No detection 1: Alarm and free stop 2: Warning and continue to run Ten digits: EX-B port disconnection action mode 0: No detection 1: Alarm and free stop 2: Warning and continue to run	0000 (0000~0022)	RUN
F12.51 (0x0C33)	Expansion port EX-A parameter update	<b>V/F SVC FVC PMVF PMSVC PMFVC</b> 0: No update 1: The initial value has been updated after power-on 2: Expansion port EX-A parameter recovery initial value	0 (0~2)	RUN
F12.52 (0x0C34)	Expansion port EX-B parameter update	<b>V/F SVC FVC PMVF PMSVC PMFVC</b> 0: No update 1: The initial value has been updated after power-on 2: Expansion port EX-n parameter recovery initial value	0 (0~2)	RUN
F12.53 (0x0C35)	Expansion port EX-A monitoring frame address group 1	<b>V/F SVC FVC PMVF PMSVC PMFVC</b> Ten digits: the lower address is 8 digits 00 to 63 Hundreds of thousands: address high 8 bits 00~07	0001 (0000~0763)	RUN
F12.54 (0x0C36)	Expansion port EX-A monitoring frame address group 2	<b>V/F SVC FVC PMVF PMSVC PMFVC</b> Ditto	0002 (0000~0763)	RUN
F12.55 (0x0C37)	Expansion port EX-A monitoring frame address group 3	<b>V/F SVC FVC PMVF PMSVC PMFVC</b> Ditto	0007 (0000~0763)	RUN
F12.56 (0x0C38)	Expansion port EX-A monitoring frame address group 4	<b>V/F SVC FVC PMVF PMSVC PMFVC</b> Ditto	0011 (0000~0763)	RUN
F12.57 (0x0C39)	Expansion port EX-B monitoring frame address group 1	<b>V/F SVC FVC PMVF PMSVC PMFVC</b> Ditto	0001 (0000~0763)	RUN
F12.58 (0x0C3A)	Expansion port EX-B monitoring frame address group 2	<b>V/F SVC FVC PMVF PMSVC PMFVC</b> Ditto	0002 (0000~0763)	RUN
F12.59 (0x0C3B)	Expansion port EX-B monitoring frame address group 3	<b>V/F SVC FVC PMVF PMSVC PMFVC</b> Ditto	0007 (0000~0763)	RUN
F12.60 (0x0C3C)	Expansion port EX-B monitoring frame address group 4	<b>V/F SVC FVC PMVF PMSVC PMFVC</b> Ditto	0011 (0000~0763)	RUN

## 4.16 F13: Process PID Control

### F13.00-F13.06: PID given and feedback

Parameter (Address)	Name	Content	Factory default (range)	Adjustable properly
F13.00 (0x0D00)	PID controller given signal source	<b>V/F SVC FVC PMVF PMSVC PMFVC</b> 0: Keyboard digital PID given 1: Keyboard analog potentiometer given 2: Current/voltage analog AI1 given 3: Current/voltage analog AI2 given 4: Reserved 5: Terminal pulse PUL given 6: RS485 communication reference 7: Option card 8: Terminal selection 9: Communication given active current	0 (0~9)	RUN
F13.01 (0x0D01)	Keyboard digital PID given / feedback	<b>V/F SVC FVC PMVF PMSVC PMFVC</b> Set keyboard digital PID given / feedback value	50.0% (0.00~100.0%)	RUN
F13.02 (0x0D02)	PID given change time	<b>V/F SVC FVC PMVF PMSVC PMFVC</b> Set the PID given change time	1.00s (0.00~60.00s)	RUN

F13.03 (0x0D03)	PID controller feedback signal source	V/F SVC FVC PMVF PMSVC PMFVC 0: keyboard digital PID feedback 1: keyboard analog potentiometer feedback 2: Current/voltage analog AI1 feedback 3: Current/voltage analog AI2 feedback 4: Reserved 5: Terminal pulse PUL feedback 6: RS485 communication feedback 7: Option card 8: Terminal selection 9: Local active current	2 (0~9)	RUN
F13.04 (0x0D04)	Feedback signal low pass filtering time	V/F SVC FVC PMVF PMSVC PMFVC Set the feedback signal low pass filter time	0.010s (0.000~6.000s)	RUN
F13.05 (0x0D05)	Feedback signal gain	V/F SVC FVC PMVF PMSVC PMFVC Set feedback signal gain	1.00 (0.00~10.00)	RUN
F13.06 (0x0D06)	Feedback signal range	V/F SVC FVC PMVF PMSVC PMFVC Set the feedback signal range	100.0 (0~100.0)	RUN

### F13.07-F13.24: PID Adjustment

Parameter (Address)	Name	Content	Factory default (range)	Adjustable properly
F13.07 (0x0D07)	PID control selection	V/F SVC FVC PMVF PMSVC PMFVC Unit position: feedback feature selection 0: Positive characteristic 1: Negative characteristic Thousands: differential adjustment properties 0: Differentiate the deviation 1: Differentiate the feedback	0100 (0000~1111)	RUN
F13.08 (0x0D08)	PID preset output	V/F SVC FVC PMVF PMSVC PMFVC Set PID preset output	100.0% (0.0~100.0%)	RUN
F13.09 (0x0D09)	PID preset output running time	V/F SVC FVC PMVF PMSVC PMFVC Set PID preset output running time	0.0s (0.0~6500.0s)	RUN
F13.10 (0x0D0A)	PID control deviation limit	V/F SVC FVC PMVF PMSVC PMFVC Set the PID control deviation limit	0.0% (0.0~100.0%)	RUN
F13.11 (0x0D0B)	Proportional gain P1	V/F SVC FVC PMVF PMSVC PMFVC Set the proportional gain P1	0.100 (0.000~4.000)	RUN
F13.12 (0x0D0C)	Integration time I1	V/F SVC FVC PMVF PMSVC PMFVC Set the integration time I1	1.0s (0.0~600.0s)	RUN
F13.13 (0x0D0D)	Differential gain D1	V/F SVC FVC PMVF PMSVC PMFVC Set the differential gain D1	0.000s (0.000~6.000s)	RUN
F13.14 (0x0D0E)	Proportional gain P2	V/F SVC FVC PMVF PMSVC PMFVC Set the proportional gain P2	0.100 (0.000~4.000)	RUN
F13.15 (0x0D0F)	Integration time I2	V/F SVC FVC PMVF PMSVC PMFVC Set the integration time I2	1.0s (0.0~600.0s)	RUN
F13.16 (0x0D10)	Differential gain D2	V/F SVC FVC PMVF PMSVC PMFVC Set the differential gain D2	0.000s (0.000~6.000s)	RUN
F13.17 (0x0D11)	PID switch condition	V/F SVC FVC PMVF PMSVC PMFVC 0: Do not switch 1: Switch with DI terminal 2: Switch according to deviation	0 (0~2)	RUN
F13.18 (0x0D12)	Switching deviation low value	V/F SVC FVC PMVF PMSVC PMFVC Set the switching deviation low value. When the PID deviation is less than this value, use the gain 1 parameter.	20.0% (0.0~100.0%)	RUN
F13.19 (0x0D13)	Switching deviation high value	V/F SVC FVC PMVF PMSVC PMFVC Set the switching deviation high value. When the PID deviation is greater than this value, use the gain 2 parameter.	80.0% (0.0~100.0%)	RUN
F13.21 (0x0D15)	Differential limiting	V/F SVC FVC PMVF PMSVC PMFVC Set differential limit	5.0% (0.0~100.0%)	RUN
F13.22 (0x0D16)	PID output upper limit	V/F SVC FVC PMVF PMSVC PMFVC Set the PID output limit	100.0% (0.0~100.0%)	RUN
F13.23 (0x0D17)	PID output lower limit	V/F SVC FVC PMVF PMSVC PMFVC Set the PID output lower limit	0.0% (-100.0~F13.22)	RUN
F13.24 (0x0D18)	PID output filtering time	V/F SVC FVC PMVF PMSVC PMFVC Set the PID output filter time	0.000s (0.000~6.000s)	RUN

## F13.25-F13.28: PID Feedback Disconnection judgment

Parameter (Address)	Name	Content	Factory default (range)	Adjustable properly
F13.25 (0x0D19)	Feedback disconnection action selection	V/F SVC FVC PMVF PMSVC PMFVC V/F SVC FVC PMVF PMSVC PMFVC 0: Continue PID operation without reporting fault 1: Stop and report fault 2: Continue PID operation and output alarm signal 3: Run at the current frequency, output alarm signal	0 (0 ~ 3)	STOP
F13.26 (0x0D1A)	Feedback disconnection detection time	V/F SVC FVC PMVF PMSVC PMFVC Set feedback disconnection detection time	1.0s (0.0 ~ 120.0s)	RUN
F13.27 (0x0D1B)	Wire break alarm upper limit	V/F SVC FVC PMVF PMSVC PMFVC Set the upper limit of the disconnection alarm	100.0 (0.0 ~ 100.0%)	RUN
F13.28 (0x0D1C)	Wire break alarm lower limit	V/F SVC FVC PMVF PMSVC PMFVC Set the upper limit of the disconnection alarm	0.0% (0.0 ~ 100.0%)	RUN

## F13.29-F13.33: PID Sleeping Function

Parameter (Address)	Name	Content	Factory default (range)	Adjustable properly
F13.29 (0x0D1D)	Sleep selection	V/F SVC FVC PMVF PMSVC PMFVC Set whether sleep is effective 0: off 1: valid	0 (0 ~ 1)	RUN
F13.30 (0x0D1E)	Sleep frequency	V/F SVC FVC PMVF PMSVC PMFVC Set sleep frequency	10.00Hz (0.00 ~ Max frequency)	RUN
F13.31 (0x0D1F)	Sleep delay	V/F SVC FVC PMVF PMSVC PMFVC Set the time of sleep delay	60.0S (0.0 ~ 3600.0S)	RUN
F13.32 (0x0D20)	Wake up deviation	V/F SVC FVC PMVF PMSVC PMFVC Set wakeup deviation	5.0% (0.0 ~ 50.0%)	RUN
F13.33 (0x0D21)	Wake-up delay	V/F SVC FVC PMVF PMSVC PMFVC Set wakeup delay	1.0S (0.0 ~ 60.0S)	RUN

## 4.17 F14: Multi-speed and Simple PLC

## F14.00~F14.14: Multi-speed given

Parameter (Address)	Name	Content	Factory default (range)	Adjustable properly
F14.00 (0x0E00)	Multi-speed 1	V/F SVC FVC PMVF PMSVC PMFVC Set PLC multi-speed 1	10.00Hz (0.00 ~ Max frequency)	RUN
F14.01 (0x0E01)	Multi-speed 2	V/F SVC FVC PMVF PMSVC PMFVC Set PLC multi-speed 2	20.00Hz (0.00 ~ Max frequency)	RUN
F14.02 (0x0E02)	Multi-speed 3	V/F SVC FVC PMVF PMSVC PMFVC Set PLC multi-speed 3	30.00Hz (0.00 ~ Max frequency)	RUN
F14.03 (0x0E03)	Multi-speed 4	V/F SVC FVC PMVF PMSVC PMFVC Set PLC multi-speed 4	40.00Hz (0.00 ~ Max frequency)	RUN
F14.04 (0x0E04)	Multi-speed 5	V/F SVC FVC PMVF PMSVC PMFVC Set PLC multi-speed 5	50.00Hz (0.00 ~ Max frequency)	RUN
F14.05 (0x0E05)	Multi-speed 6	V/F SVC FVC PMVF PMSVC PMFVC Set PLC multi-speed 6	40.00Hz (0.00 ~ Max frequency)	RUN
F14.06 (0x0E06)	Multi-speed 7	V/F SVC FVC PMVF PMSVC PMFVC Set PLC multi-speed 7	30.00Hz (0.00 ~ Max frequency)	RUN

F14.07 (0x0E07)	Multi-speed 8	V/F SVC FVC PMVF PMSVC PMFVC Set PLC multi-speed 8	20.00Hz (0.00~Max frequency)	RUN
F14.08 (0x0E08)	Multi-speed 9	V/F SVC FVC PMVF PMSVC PMFVC Set PLC multi-speed 9	10.00Hz (0.00~Max frequency)	RUN
F14.09 (0x0E09)	Multi-speed 10	V/F SVC FVC PMVF PMSVC PMFVC Set PLC multi-speed 10	20.00Hz (0.00~Max frequency)	RUN
F14.10 (0x0E0A)	Multi-speed 11	V/F SVC FVC PMVF PMSVC PMFVC Set PLC multi-speed 11	30.00Hz (0.00~Max frequency)	RUN
F14.11 (0x0E0B)	Multi-speed 12	V/F SVC FVC PMVF PMSVC PMFVC Set PLC multi-speed 12	40.00Hz (0.00~Max frequency)	RUN
F14.12 (0x0E0C)	Multi-speed 12	V/F SVC FVC PMVF PMSVC PMFVC Set PLC multi-speed 12	50.00Hz (0.00~Max frequency)	RUN
F14.13 (0x0E0D)	Multi-speed 14	V/F SVC FVC PMVF PMSVC PMFVC Set PLC multi-speed 14	40.00Hz (0.00~Max frequency)	RUN
F14.14 (0x0E0E)	Multi-speed 15	V/F SVC FVC PMVF PMSVC PMFVC Set PLC multi-speed 15	30.00Hz (0.00~Max frequency)	RUN

### F14.15: PLC Operation Mode Selection

Parameter (Address)	Name	Content	Factory default (range)	Adjustable properly
F14.15 (0x0E0F)	PLC Operation mode selection	V/F SVC FVC PMVF PMSVC PMFVC Unit position: cycle mode 0: Stop after single cycle 1: Continuous cycle 2: Keep the final value after single cycle Ten place: timing unit 0: second 1: minute 2: hour Hundreds: Power-down storage 0: no storage 1: storage Thousands: Startup mode 0: Re-run from the first stage 1: Re-run from the phase of the downtime 2: continue to run for the rest of the downtime phase	0000 (0000 ~ 2122)	RUN

### F14.16~F14.30: PLC Operation Time Selection

Parameter (Address)	Name	Content	Factory default (range)	Adjustable properly
F14.16 (0x0E10)	PLC 1st stage running time	V/F SVC FVC PMVF PMSVC PMFVC Set PLC 1st stage running time	10.0 (0.0~6500.0(s/mh))	RUN
F14.17 (0x0E11)	PLC 2nd stage running time	V/F SVC FVC PMVF PMSVC PMFVC Set PLC 2nd stage running time	10.0 (0.0~ 6500.0(s/mh))	RUN
F14.18 (0x0E12)	PLC 3rd stage running time	V/F SVC FVC PMVF PMSVC PMFVC Set PLC 3rd stage running time	10.0 (0.0~ 6500.0(s/mh))	RUN
F14.19 (0x0E13)	PLC 4th stage running time	V/F SVC FVC PMVF PMSVC PMFVC Set PLC 4th stage running time	10.0 (0.0~ 6500.0(s/mh))	RUN
F14.20 (0x0E14)	PLC 5th stage running time	V/F SVC FVC PMVF PMSVC PMFVC Set PLC 5th stage running time	10.0 (0.0~ 6500.0(s/mh))	RUN
F14.21 (0x0E15)	PLC 6th stage running time	V/F SVC FVC PMVF PMSVC PMFVC Set PLC 6th stage running time	10.0 (0.0~ 6500.0(s/mh))	RUN
F14.22 (0x0E16)	PLC 7th stage running time	V/F SVC FVC PMVF PMSVC PMFVC Set PLC 7th stage running time	10.0 (0.0~ 6500.0(s/mh))	RUN

F14.23 (0x0E17)	PLC 8th stage running time	V/F SVC FVC PMVF PMSVC PMFVC Set PLC 8h stage running time	10.0 (0.0~ 6500.0(s/mh))	RUN
F14.24 (0x0E18)	PLC 9th stage running time	V/F SVC FVC PMVF PMSVC PMFVC Set PLC 9th stage running time	10.0 (0.0~ 6500.0(s/mh))	RUN
F14.25 (0x0E19)	PLC 10th stage running time	V/F SVC FVC PMVF PMSVC PMFVC Set PLC 10th stage running time	10.0 (0.0~ 6500.0(s/mh))	RUN
F14.26 (0x0E1A)	PLC11th stage running time	V/F SVC FVC PMVF PMSVC PMFVC Set PLC 11th stage running time	10.0 (0.0~ 6500.0(s/mh))	RUN
F14.27 (0x0E1B)	PLC 12th stage running time	V/F SVC FVC PMVF PMSVC PMFVC Set PLC 12th stage running time	10.0 (0.0~ 6500.0(s/mh))	RUN
F14.28 (0x0E1C)	PLC 13th stage running time	V/F SVC FVC PMVF PMSVC PMFVC Set PLC 13th stage running time	10.0 (0.0~ 6500.0(s/mh))	RUN
F14.29 (0x0E1D)	PLC 14th stage running time	V/F SVC FVC PMVF PMSVC PMFVC Set PLC 14th stage running time	10.0 (0.0~6500.0(s/mh))	RUN
F14.30 (0x0E1E)	PLC 15th stage running time	V/F SVC FVC PMVF PMSVC PMFVC Set PLC 15th stage running time	10.0 (0.0~ 6500.0(s/mh))	RUN

#### F14.31~F14.45: PLC Operation Direction and Time Selection

Parameter (Address)	Name	Content	Factory default (range)	Adjustable properly
F14.31 (0x0E1F)	PLC direction and acceleration and deceleration time of 1st stage	V/F SVC FVC PMVF PMSVC PMFVC Unit: The running direction of this segment (compared with the running command) 0: same direction 1: reverse Ten digits: acceleration and deceleration time of this section 0: Acceleration/deceleration time 1 1: Acceleration/deceleration time 2 2: Acceleration/deceleration time 3 3: Acceleration/deceleration time 4	0000 (0000-0031)	RUN
F14.32 (0x0E20)	PLC direction and acceleration and deceleration time of 2nd stage	V/F SVC FVC PMVF PMSVC PMFVC The same settings as F14.31	0000 (0000-0031)	RUN
F14.33 (0x0E21)	PLC direction and acceleration and deceleration time of 3rd stage	V/F SVC FVC PMVF PMSVC PMFVC The same settings as F14.31	0000 (0000-0031)	RUN
F14.34 (0x0E22)	PLC direction and acceleration and deceleration time of 4th stage	V/F SVC FVC PMVF PMSVC PMFVC The same settings as F14.31	0000 (0000-0031)	RUN
F14.35 (0x0E23)	PLC direction and acceleration and deceleration time of 5th stage	V/F SVC FVC PMVF PMSVC PMFVC The same settings as F14.31	0000 (0000-0031)	RUN
F14.36 (0x0E24)	PLC direction and acceleration and deceleration time of 6th stage	V/F SVC FVC PMVF PMSVC PMFVC The same settings as F14.31	0000 (0000-0031)	RUN
F14.37 (0x0E25)	PLC direction and acceleration and deceleration time of 7th stage	V/F SVC FVC PMVF PMSVC PMFVC The same settings as F14.31	0000 (0000-0031)	RUN
F14.38 (0x0E26)	PLC direction and acceleration and deceleration time of 8th stage	V/F SVC FVC PMVF PMSVC PMFVC The same settings as F14.31	0000 (0000-0031)	RUN
F14.39 (0x0E27)	PLC direction and acceleration and	V/F SVC FVC PMVF PMSVC PMFVC The same settings as F14.31	0000 (0000-0031)	RUN

	deceleration time of 9th stage			
F14.40 (0x0E28)	PLC direction and acceleration and deceleration time of 10th stage	<b>V/F SVC FVC PMVF PMSVC PMFVC</b> The same settings as F14.31	0000 (0000-0031)	RUN
F14.41 (0x0E29)	PLC direction and acceleration and deceleration time of 11th stage	<b>V/F SVC FVC PMVF PMSVC PMFVC</b> The same settings as F14.31	0000 (0000-0031)	RUN
F14.42 (0x0E2A)	PLC direction and acceleration and deceleration time of 12th stage	<b>V/F SVC FVC PMVF PMSVC PMFVC</b> The same settings as F14.31	0000 (0000-0031)	RUN
F14.43 (0x0E2B)	PLC direction and acceleration and deceleration time of 13th stage	<b>V/F SVC FVC PMVF PMSVC PMFVC</b> The same settings as F14.31	0000 (0000-0031)	RUN
F14.44 (0x0E2C)	PLC direction and acceleration and deceleration time of 14th stage	<b>V/F SVC FVC PMVF PMSVC PMFVC</b> The same settings as F14.31	0000 (0000-0031)	RUN
F14.45 (0x0E2D)	PLC direction and acceleration and deceleration time of 15th stage	<b>V/F SVC FVC PMVF PMSVC PMFVC</b> The same settings as F14.31	0000 (0000-0031)	RUN

## 4.18 C0x: Monitoring Parameter

### C00: Basic Monitoring

Parameter (Address)	Name	Parameter (Address)	Name
C00.00 (0x2100)	Given frequency	C00.20 (0x2114)	Analog output AO
C00.01 (0x2101)	Output frequency	C00.21 (0x2115)	Reserved
C00.02 (0x2102)	Output current	C00.22 (0x2116)	Counter count value
C00.03 (0x2103)	Input voltage	C00.23 (0x2117)	Power-on running time
C00.04 (0x2104)	The output voltage	C00.24 (0x2118)	Accumulated running time of the machine
C00.05 (0x2105)	Mechanical speed	C00.25 (0x2119)	Inverter power level
C00.06 (0x2106)	Given torque	C00.26 (0x211A)	Inverter rated voltage
C00.07 (0x2107)	Output torque	C00.27 (0x211B)	Inverter rated current
C00.08 (0x2108)	PID given	C00.28 (0x211C)	Software version
C00.09 (0x2109)	PID feedback	C00.29 (0x211D)	PG feedback frequency
C00.10 (0x210A)	Output Power	C00.30 (0x211E)	Timer timing
C00.11 (0x210B)	bus voltage	C00.31 (0x211F)	PID output value
C00.12 (0x210C)	Module temperature 1	C00.32 (0x2120)	Inverter software subversion
C00.13 (0x210D)	Module temperature 2	C00.33 (0x2121)	Encoder feedback angle
C00.14 (0x210E)	Input terminal X is on (Note)	C00.34 (0x2122)	Z pulse cumulative error
C00.15 (0x210F)	Output terminal Y is on (Note)	C00.35 (0x2123)	Z pulse count
C00.16 (0x2110)	Analog AI1 input value	C00.36 (0x2124)	Failure warning code
C00.17 (0x2111)	Analog AI2 input value	C00.37 (0x2125)	Cumulative power consumption (low level)
C00.18 (0x2112)	Keyboard potentiometer input value	C00.38 (0x2126)	Cumulative power consumption (high)
C00.19 (0x2113)	Pulse signal PUL input value	C00.39 (0x2127)	Power factor angle

Note: For example, when terminals X1 and X2 are ON, C00.14 is displayed as



. When terminal Y and relay are ON, C00.15 is

displayed as **C01: Fault Monitoring**

Parameter (Address)	Name	Parameter (Address)	Name
C01.00 (0x2200)	Fault type	C01.12 (0x220C)	The first fault operation frequency
C01.01 (0x2201)	Troubleshooting information	C01.13 (0x220D)	Last fault output voltage
C01.02 (0x2202)	Fault operating frequency	C01.14 (0x220E)	Last fault output current
C01.03 (0x2203)	Fault output voltage	C01.15 (0x220F)	The first fault bus voltage
C01.04 (0x2204)	Fault output current	C01.16 (0x2210)	The first fault module temperature
C01.05 (0x2205)	Fault bus voltage	C01.17 (0x2211)	The first faulty inverter status
C01.06 (0x2206)	Faulty module temperature	C01.18 (0x2212)	The first fault input terminal status
C01.07 (0x2207)	Faulty inverter status	C01.19 (0x2213)	The first fault output terminal status
C01.08 (0x2208)	Fault input terminal status	C01.20 (0x2214)	First 2 fault types
C01.09 (0x2209)	Fault output terminal status	C01.21 (0x2215)	The first 2 troubleshooting information
C01.10 (0x220A)	Previous failure type	C01.22 (0x2216)	Top 3 fault types
C01.11 (0x220B)	Previous troubleshooting information	C01.23 (0x2217)	The first 3 troubleshooting information

**C02: Application Monitoring**

Parameter (Address)	Name	Parameter (Address)	Name
C02.00 (0x2300)	PID feedback	C02.08 (0x2308)	Fwd and Rev command given
C02.01 (0x2301)	PID given	C02.09 (0x2309)	Jog command given
C02.02 (0x2302)	PID output	C02.60 (0x233C)	Expansion card A version
C02.03 (0x2303)	PID control status	C02.61 (0x233D)	Expansion card B version
C02.05 (0x2305)	PLC operation phase	C02.62 (0x233E)	External keyboard version
C02.06 (0x2306)	PLC phase frequency	C02.63 (0x233F)	Built-in keyboard version
C02.07 (0x2307)	PLC phase running time		

**4.19 Terminal Selection Function**

Terminal X	Function Interpretation	Terminal X	Function Interpretation	Terminal X	Function Interpretation
0	No function	21	PID control pause	42	Counter clock input terminal
1	Forward running	22	PID characteristic switching	43	Counter clear terminal
2	Reverse run	23	PID parameter switching	44	DC brake command
3	Three-wire operation control (Xi)	24	PID given switch 1	45	Pre-excitation command terminal
4	Forward turn	25	PID given switch 2	46	Reserved
5	Reverse jog	26	PID given switch 3	47	Reserved
6	Free parking	27	PID feedback switching 1	48	Command channel switch to keyboard
7	emergency pull over	28	PID feedback switching 2	49	Command channel switch to terminal
8	Fault reset	29	PID feedback switching 3	50	Command channel switch to communication
9	External fault input	30	Program run (PLC) pause	51	Command channel switch to expansion card
10	Frequency increment (UP)	31	Program run (PLC) restart	52	Run prohibition
11	Frequency decrement (DW)	32	Acceleration/deceleration time selection terminal 1	53	Forward prohibition



12	Frequency increment decrement clear (UP/DW/clear)	33	Acceleration/deceleration time selection terminal 2	54	Reverse prohibition
13	Channel A switches to channel B	34	Suspension acceleration	55	Reserved
14	Switch the frequency channel combination to A	35	Swing frequency input	56	Reserved
15	Switch the frequency channel combination to B	36	Swing frequency pause	57	Zero servo command
16	Multi-speed terminal 1	37	Swing frequency reset	58	Run output blocking command
17	Multi-speed terminal 2	38	Keyboard button and display self-test selection	59	Reserved
18	Multi-speed terminal 3	39	X5 or X10 (extended) frequency measurement	60	Speed torque control switching
19	Multi-speed terminal 4	40	Timer trigger terminal	61	Reserved
20	PID control canceled	41	Timer clear terminal	62	Reserved
Terminal Y	Function Interpretation	Terminal Y	Function Interpretation	Terminal Y	Function Interpretation
0	no output	14	Lower limit frequency arrival	28	Underload pre-alarm output 2
1	The inverter is running	15	Program run cycle completion	29	Inverter warning
2	Inverter running in reverse	16	The running phase of the program is completed.	30	Communication address 0x3018 control output
3	The inverter is running in forward rotation	17	PID feedback exceeds the upper limit	31	Inverter overheat warning
4	Fault trip alarm 1 (alarm during fault self-recovery)	18	PID feedback is below the lower limit	32	Motor overheat alarm output
5	Fault trip alarm 2 (no alarm during fault self-recovery)	19	PID feedback sensor disconnection	33	Frequency (speed) is consistent 1
6	External downtime	20	Meter length arrives	34	Any frequency (speed) is consistent 1
7	Inverter undervoltage	21	Timer time to	35	Frequency detection 1
8	The inverter is ready for operation	22	Counter reaches maximum	36	Frequency detection 2
9	Output frequency level detection 1 (FDT1)	23	Counter reaches the set value	37	Frequency (speed) is consistent 2
10	Output frequency level detection 2 (FDT2)	24	Energy consumption braking	38	Any frequency (speed) is consistent 2
11	Arrived at a given frequency	25	PG feedback disconnection	39	Frequency detection 3
12	Zero speed operation	26	Emergency stop	40	Frequency detection 4
13	Upper limit frequency arrival	27	Overload pre-alarm output 1		

## 4.20 Fault and Warning Code Table

Note: The numbers in parentheses are fault codes or warning codes (Dec. means decimal).

Keyboard display (Dec.)	Fault name	Fault type	Keyboard display (Dec.)	Fault name	Fault type
E.SC1 ( 1 )	Accelerated system failure	Fault	E.LD1 ( 79 )	Load protection 1	Fault
E.SC2 ( 2 )	System failure during deceleration	Fault	E.LD2 ( 80 )	Load protection 2	Fault
E.SC3 ( 3 )	Constant speed system failure	Fault	E.CPU ( 81 )	CPU timeout failure	Fault
E.SC4 ( 4 )	Downtime system failure	Fault	E.LOC ( 85 )	Chip lock	Fault
E.OC1 ( 5 )	Overcurrent in acceleration	Fault	E.EEP ( 86 )	Parameter storage failure	Fault
E.OC2 ( 6 )	Overcurrent during deceleration	Fault	E.PLL ( 87 )	Phase-locked loop failure	Fault
E.OC3 ( 7 )	Overcurrent at constant speed	Fault	E.BUS1 ( 91 )	Expansion card A disconnected	Fault
E.OU1 ( 9 )	Accelerating overvoltage	Fault	E.BUS2 ( 92 )	Expansion card B is broken	Fault
E.OU2 ( 10 )	Overvoltage during deceleration	Fault	E.BUS3 ( 93 )	CAN expansion card failure	Fault
E.OU3 ( 11 )	Overvoltage at constant speed	Fault	E.BUS4 ( 94 )	Other expansion card failure	Fault
E.LU ( 13 )	Undervoltage in operation	Fault	E.BUS5 ( 95 )	Other expansion card failure	Fault

E.OL1 (14)	Motor overload	Fault	E.BUS6 (96)	Other expansion card disconnection	Fault
E.OL2 (15)	Inverter overload 1	Fault	E.CP1 (97)	Monitor compare output 1 fault	Fault
E.OL3 (16)	Inverter overload 2 continuous CBC	Fault	E.CP2 (98)	Monitor compare output 2 fault	Fault
E.OL4 (17)	Inverter overload 3	Fault	E.DAT (99)	Parameter setting error	Fault
E.ILF (18)	Input phase loss	Fault	E.FA1 (110)	External extension reserve 1	Fault
E.OLF (19)	Three phase output phase loss	Fault	E.FA2 (111)	External extension reserve 2	Fault
E.OLF1 (20)	U phase output phase loss	Fault	E.FA3 (112)	External extension reserve 3	Fault
E.OLF2 (21)	V phase output phase loss	Fault	E.FA4 (113)	External extension reserve 4	Fault
E.OLF3 (22)	W phase output phase loss	Fault	E.FA5 (114)	External extension reserve 5	Fault
E.OH1 (30)	Rectifier module over temperature	Fault	E.FA6 (115)	External extension reserve 6	Fault
E.OH2 (31)	IGBT module over temperature	Fault	E.FA7 (116)	External extension reserve 7	Fault
E.OH3 (32)	Motor over temperature	Fault	E.FA8 (117)	External extension reserve 8	Fault
E.EF (33)	External fault	Fault	The following is the warning code		
E.CE (34)	Modbus communication failure	Fault			
E.HAL1 (35)	U phase zero drift excessive	Fault	A.LU1 (128)	Undervoltage during stopping	Warning
E.HAL2 (36)	V phase zero drift excessive	Fault	A.OU (129)	Overvoltage during stopping	Warning
E.HAL (37)	Sum of Three-phase current is not 0 fault	Fault	A.ILF (130)	Input phase loss	Warning
E.HAL3 (38)	W phase zero drift excessive	Fault	A.PID (131)	PID feedback disconnection	Warning
E.SGxx (40)	Short circuit to ground	Fault	A.EEP (132)	Parameter storage warning	Warning
E.FSG (41)	Fan short circuit	Fault	A.DEF (133)	Speed deviation excessive	Warning
E.PID (42)	PID feedback disconnection	Fault	A.SPD (134)	Speed warning	Warning
E.COP (43)	Parameter copy failure	Fault	A.GPS1 (135)	GPS locked	Warning
E.PG1 (44)	PG parameter setting error	Fault	A.GPS2 (136)	GPS disconnection	Warning
E.PG2 (44)	Encoder Z pulse failure	Fault	A.CE (137)	External warning	Warning
E.PG3 (44)	Rotation check error	Fault	A.LD1 (138)	Load protection 1	Warning
E.PG4 (44)	Rotational disconnection	Fault	A.LD2 (139)	Load protection 2	Warning
E.PG5 (44)	ABZ encoder disconnection	Fault	A.BUS (140)	Expansion card disconnection warning	Warning
E.PG6 (44)	Spindle encoder disconnection	Fault	A.OH1 (141)	Module over temperature warning	Warning
E.PG7 (44)	Spindle encoder Z pulse error fault	Fault	A.OH3 (142)	Motor over temperature warning	Warning
E.PG8 (44)	Encoder Z pulse logic fault	Fault	A.RUN1 (143)	Run command conflict	Warning
E.PG9 (44)	Spindle encoder Z pulse logic fault	Fault	A.RUN2 (158)	Jog terminal start protection	Warning
E.PG10 (44)	Encoder Z pulse disconnection	Fault	A.RUN3 (159)	Terminal start protection	Warning
E.BRU (50)	Brake unit failure	Fault	A.PA2 (144)	External keyboard disconnection warning	Warning
E.TExx (52)	Motor parameter self-learning fault	Fault	A.COP (145)	Parameter copy warning	Warning
E.IAE1 (71)	Motor angle learning fault 1	Fault	A.CP1 (146)	Monitor comparison output 1 warning	Warning
E.IAE2 (72)	Motor angle learning fault 2	Fault	A.CP2 (147)	Monitor comparison output 2 warning	Warning
E.IAE3 (73)	Motor angle learning fault 3	Fault	A.FA1 (150)	External extension reserve 1	Warning
E.PST1 (74)	Synchronous machine out of step fault 1	Fault	A.FA2 (151)	External extension reserve 2	Warning
E.PST2 (75)	Synchronous machine out of step fault 2	Fault	A.FA3 (152)	External extension reserve 3	Warning
E.PST3 (76)	Synchronous machine out of step fault 3	Fault	A.FA4 (153)	External extension reserve 4	Warning
E.DEF (77)	Speed deviation excessive	Fault	A.FA5 (154)	External extension reserve 5	Warning
E.SPD (78)	Speed exceed fault	Fault	A.FA6 (155)	External extension reserve 6	Warning

## 5 Inspection, Maintenance and Guarantee

### 5.1 Inspection

The frequency converter consists of semiconductor devices, passive electronic components, and moving devices. These devices have a service life. Even under normal working conditions, some devices may have characteristic changes or failures if they exceed the service life. In order to prevent this phenomenon from causing malfunctions, it is necessary to perform preventive inspection and maintenance such as daily inspection, periodic inspection, and device replacement. It is recommended to check every 3 or 4 months after installation.

- Daily inspection: In order to avoid damage to the inverter and shorten the service life, please confirm the following items daily.

Items	Content	Solution
Power supply	Check if the power supply voltage meets the requirements and whether there is a lack of phase power supply.	Resolve as required on the nameplate.
Surroundings	Whether the installation environment meets the requirements.	Confirm the source and solve it properly.
cooling system	Whether the inverter and the motor have abnormal heating and discoloration, and check the working status of cooling fans .	Check if the overload, fixing screw, and the heat sink of the inverter are dirty, and check if the fan is blocked.
Motor	Whether the motor has abnormal vibration and abnormal sound.	Fasten mechanical and electrical connections and lubricate mechanical parts.
Load condition	Whether the output current of the inverter is higher than the rated value of the motor or the inverter for a certain period of time.	Check if an overload condition occurs and confirm that the model of the inverter is selected correctly.

- Regular inspection: In general, it is advisable to conduct regular inspections every 3 months or 4 months, but in actual cases, please determine the actual inspection period based on the use of each machine and the working environment.

Items	Content	Solution
overall	Insulation resistance check; environmental inspection.	Fasten and replace bad parts; clean and improve the operating environment.
Electrical connections	<ul style="list-style-type: none"> <li>• Whether the wires and connections are discolored, whether the insulation is damaged, cracked, discolored, or aged;</li> <li>• Whether the connection terminals are worn, damaged or loose;</li> <li>• Grounding check.</li> </ul>	<ul style="list-style-type: none"> <li>• Replace damaged wires;</li> <li>• Tighten the loose terminals and replace the damaged terminals;</li> <li>• Measure the grounding resistance and tighten the corresponding grounding terminal.</li> </ul>
Mechanical connection	<ul style="list-style-type: none"> <li>• Whether there is abnormal vibration and noise, and whether there is looseness.</li> </ul>	<ul style="list-style-type: none"> <li>• Fasten, lubricate, and replace defective parts.</li> </ul>
Semiconductor components	<ul style="list-style-type: none"> <li>• Whether it is contaminated with garbage and dust;</li> <li>• Whether there is a significant change in appearance.</li> </ul>	<ul style="list-style-type: none"> <li>• Clean the operating environment;</li> <li>• Replace damaged parts.</li> </ul>
Electrolytic capacitor	<ul style="list-style-type: none"> <li>• Whether it leaks, discolors, cracks, whether the safety valve is exposed, swells, ruptures or leaks.</li> </ul>	<ul style="list-style-type: none"> <li>• Replace damaged parts.</li> </ul>
peripheral equipment	<ul style="list-style-type: none"> <li>• Peripheral device appearance and insulation inspection.</li> </ul>	<ul style="list-style-type: none"> <li>• Clean the environment and replace damaged parts.</li> </ul>
A printed circuit board	<ul style="list-style-type: none"> <li>• Whether there is odor, discoloration, severe rust, and the connector is correct and reliable.</li> </ul>	<ul style="list-style-type: none"> <li>• Fasten the connector;</li> <li>• Clean the printed circuit board;</li> <li>• Replace damaged printed circuit boards;</li> </ul>
cooling system	<ul style="list-style-type: none"> <li>• Whether the cooling fan is damaged or blocked;</li> <li>• Whether the heat sink is stained with dirt, dust and dirt;</li> <li>• Whether the air inlet and exhaust port are blocked or contaminated with foreign matter.</li> </ul>	<ul style="list-style-type: none"> <li>• Clean the operating environment;</li> <li>• Replace damaged parts.</li> </ul>
keyboard	<ul style="list-style-type: none"> <li>• Whether the keyboard is damaged or defective.</li> </ul>	<ul style="list-style-type: none"> <li>• Replace damaged parts.</li> </ul>
Motor	<ul style="list-style-type: none"> <li>• Whether the keyboard is damaged or defective.</li> </ul>	<ul style="list-style-type: none"> <li>• Fasten mechanical and electrical connections and lubricate the motor shaft.</li> </ul>



: Do not perform related work while the power is on, otherwise there is a danger of death due to electric shock. When performing related work, please cut off the power supply and confirm that the DC voltage of the main circuit has dropped to a safe level, and wait 5 minutes before performing related work.

## 5.2 Maintenance

All equipment and components have a service life. Proper maintenance can extend the life, but it cannot solve the damage of equipment and equipment. Please replace the equipment according to requirements.

Item	Service life	Item	Service life	Item	Service life
Fans	2~3 years	Electrolytic capacitor	4~5 years	PCB	8~10 years

The replacement of other devices is very strict with the maintenance technology and product familiarity, and must be strictly tested before being replaced before use. Therefore, it is not recommended to replace other internal components. If you do need to replace it, please contact the agent where you purchased the product or the sales department of the company.

## 5.3 Product Warranty

1. The product during the warranty period is faulty. For details, please refer to the warranty terms in the warranty card.
2. Primary fault diagnosis is implemented by customs' company in principle, but can be provided by our company or our company's service network according to the requirements of your company. According to the results of negotiations with your company, the company will provide free services for the reasons of the failure.
3. Liability exemption, due to the company's product failure, the inconvenience caused to your company or your company's customers and the damage caused by non-Company products, whether within the warranty period or not, are not within the scope of the company's responsibility.

# Appendix I: Modbus Communication Protocol

## ●Communication frame structure

The communication data format is as follows:

The composition of the byte: including the start bit, 8 data bits, check bit and stop bit.

Start Bit	Bit1	Bit2	Bit3	Bit4	Bit5	Bit6	Bit7	Bit8	Check bit	Stop bit
-----------	------	------	------	------	------	------	------	------	-----------	----------

The information of a frame must be transmitted in a continuous stream. If the interval of more than 1.5 bytes before the end of the entire frame transmission, the receiving device will clear the incomplete information and mistakenly believe that the next byte is the address field portion of a new frame. Similarly, if the interval between the start of a new frame and the previous frame is less than 3.5 bytes, the receiving device will consider it to be the continuation of the previous frame. Due to the disorder of the frame, the CRC check value is incorrect, resulting in communication error.

Standard structure of RTU frames:

Frame header	3.5 bytes of transmission time
Slave address	mailing address: 0 to 247 (decimal) (0 is the broadcast address)
Command code	03H: Read slave parameters 06H: Write slave parameters 08H: Loop self-test
Data area	Parameter address, number of parameters, parameter value, etc.
Low CRC CHK	Detection value: 16-bit CRC check value
High CRC CHK	
End of frame	3.5 bytes of transmission time

## ●Command code and communication data description

Take the read parameter command code as an example.

For example, if the slave address is 01H, the memory start address is 2100H (monitoring parameter C00.00), and if three consecutive words are read, the structure of the frame is described as follows:

RTU host command information		RTU slave response information (normal)	
Slave address	01H	Host address	01H
Command code	03H	Command code	03H
High start address	21H	Low number of bytes	06H
Low start address	00H	High data address 2100H	13H
High number of data	00H	Low data address 2100H	88H
Low number of data	03H	High data address 2101H	00H
Low CRC CHK	0FH	Low data address 2101H	00H
High CRC CHK	F7H	High data address 2102H	00H
		Low data address 2102H	00H
		Low CRC CHK	90H
		High CRC CHK	A6H
		RTU slave response information (abnormal)	

		Slave address	01H
		Command code	83H
		Fault code	04H
		Low CRC CHK	40H
		High CRC CHK	F3H

### ●Communication control parameter group address description

Function Description	Address Definition	Data meaning		Characteristics
Communication given	0x3000 or 0x2000	0~32000 correspond to 0.00Hz~320.00Hz		W/R
Communication command setting	0x3001 or 0x2001	0x0000:no command 0x0001:FWD run 0x0002:REV run 0x0003:FWD Jog 0x0004:REV Jog	0x0005:Dec stop 0x0006:free stop 0x0007:Fault reset 0x0008:Run prohibition command 0x0009:Run permission command	W/R
Inverter status	0x3002 or 0x2002	Bit0	0:Stop status 1:Running status	R
		Bit1	0:Non-Acc 1:Acc status	
		Bit2	0:Non-Dec 1:Dec status	
		Bit3	0:Foward 1:Reverse	
		Bit4	0:No fault 1:Inverter fault	
		Bit5	0:GPRS unlock 1:GPRS locked	
		Bit6	0:No warning 1:Inverter	
Inverter fault code	0x3003 or 0x2003	Inverter current fault code (see fault code table)		R
Communication given upper limit frequency	0x3004 or 0x2004	0~32000 correspond to 0.00Hz~320.00Hz		W/R
Communication torque setting	0x3005 or 0x2005	0~1000 correspond to 0.0~100.0%		W/R
Torque control positive maximum frequency limit	0x3006 or 0x2006	0~1000 correspond to 0.0~100.0%		W/R
Torque control reverse maximum frequency limit	0x3007 or 0x2007	0~1000 correspond to 0.0~100.0%		W/R
Communication given PID set value	0x3008 or 0x2008	0~1000 correspond to 0.0~100.0%		W/R
Communication given PID feedback value	0x3009 or 0x2009	0~1000 correspond to 0.0~100.0%		W/R
Fault and warning code reading	0x3010 or 0x2010	Fault code:0~127 Warning code:128 and above		R
Output terminal status	0x3018 or 0x2018	External inverter output terminal, Bit0 - Y Bit1 - TA1-TB1-TC1; Bit2 - extended Y1 (with IO expansion card) BIT3 - Extended relay (with IO expansion card)		R
AO output	0x3019 or 0x2019	0-10000 correspond to Output 0-10V/0-20mA		R

Note: For other function code addresses, see the "Address" column in the function code profile

When using the writing command (06H) to write the F00-F15 parameters, if the function code parameter address field high nibble is 0, only write in the inverter RAM, won't be stored when power down; if the function code parameter address field high nibble is 1, written in the EEPROM, and will be stored when power down.

For example parameter F00.xx: 0x00xx (write in RAM), 0x10xx (stored in EEPROM); parameter F01.xx: 0x01xx (write in RAM) 0x11xx (stored in EEPROM), and so on, for other parameters. When reading the F00-F15 parameter group parameters, the address high nibble is 0, such as reading the parameter F03.xx: 0x03xx.

When using the write command (06H) to write F16-F29 parameters, if the function code parameter address field high nibble is 5, only write in to the

inverter RAM, won't be stored when power down; if the function code parameter address field high nibble is D, written in the EEPROM, will be stored when power down.

For example, parameter F16.xx: 0x50xx (write in RAM) 0xD0xx (stored in EEPROM); parameter F17.xx: 0x51xx (write in RAM) 0xD1xx (stored in EEPROM), and so on other group parameters. When reading the F16~F29 parameter group parameters, the address high nibble is 5, such as reading the parameter F18.xx: 0x52xx.

### ●The error code meaning of slave abnormal response information

Code	Description	Code	Description	Code	Description
1	Command code error	3	CRC check error	4	Illegal address
5	Illegal data	6	Parameter cannot be modified during running	8	The inverter is busy (EEPROM is being stored)
9	Parameter value exceed	10	Reserved parameter cannot be modified	11	The number of bytes is incorrect when reading parameter.

# Appendix II: Terminal wiring method

## 0: Two-wire control 1

The operation is in one direction. This mode is the most commonly used two-wire mode. The factory default is to determine the forward and reverse running of the motor by the X1 (forward running) and X2 (reverse running) terminal commands. As shown below:

K1	K2	running command
0	0	Stop
1	0	Forward
0	1	Reverse
1	1	Stop

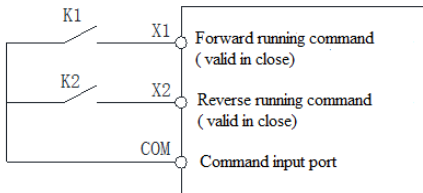

0: Two-wire control 1 schematic

## 1: Two-wire control 2

The operation is separated from the direction. The forward running terminal X1 (forward running) defined in this mode is the operation enable terminal. The definition of the direction is determined by the state of the reverse running terminal X2 (reverse running). As shown below:

K1	K2	running command
0	0	Stop
1	0	Forward
1	1	Reverse
0	1	Stop

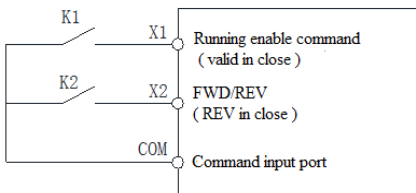

1: Two-wire control 2 schematic

## 2: Three-wire control 1

In this mode, the three-wire operation control terminal (Xi) is the stop operation terminal, and the running command is generated by the forward rotation operation terminal X1 (forward rotation operation), and the direction is controlled by the reverse rotation operation terminal X2 (reverse rotation operation). The three-wire operation control terminal (Xi) is an effective input.

K1	direction control
0	FWD
1	REV

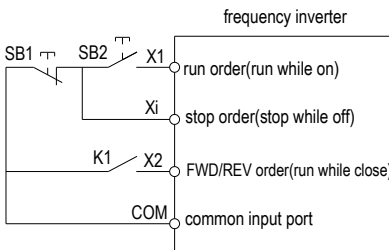

2: 3-line 1

2: Three-wire control 1 schematic

## 3: Three-wire control 2

In this mode, the three-wire operation control terminal (Xi) is the stop operation terminal, and the operation command is generated by the forward rotation operation terminal X1 (forward rotation operation) or the reverse rotation operation terminal X2 (reverse rotation operation), and both control the running direction.



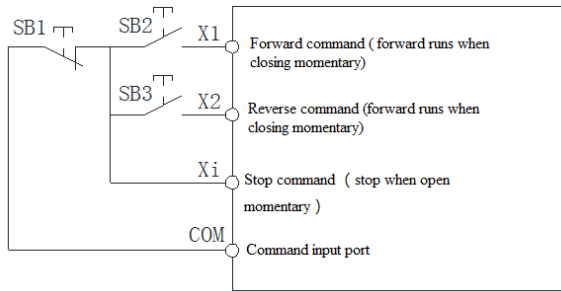

3: Three-wire control 2 schematic

Hint: SB1: stop button; SB2: forward run button; SB3: reverse run button; "Xi" is the multi-function input terminal when set to "3" [three-wire operation control (Xi)].

