

Product selection guide

VEDA^{IN}DRIVES

VEDA-in DRIVES RD series

Variable frequency converters for diverse automation applications



vedaindrives.com

VEDA-IN DRIVES RD SERIES – Overview

We are proud to announce our new line of VEDA-IN DRIVES variable frequency drives developed based on 15+ years of experience in the drive technology market. The development of new products was based on the operating experience of various frequency converters, feedback from partners and customers and the technical capabilities of suppliers.

Delivering a higher reliability at competitive price, VEDA-IN RD series successfully passed all the necessary certifications. The modular design allows to easily adapt driver functionality to meet specific applications and requirements.

Our products offer automatic engine identification capability for simple and easy configuration. The drive can be programmed using an integrated operator panel or a dedicated software.

VEDA-IN DRIVES variable frequency drives are covered by warranty and post-warranty services supported by a partner network. With our own R&D center, we can continuously improve the drive software to meet demanding application requirements.

VEDA-IN RD series are widely used for water supply and wastewater disposal, heating, ventilation and air conditioning (HVAC), chemical and mining industries, lifts and cranes, shipbuilding, oil and gas production, power generation.

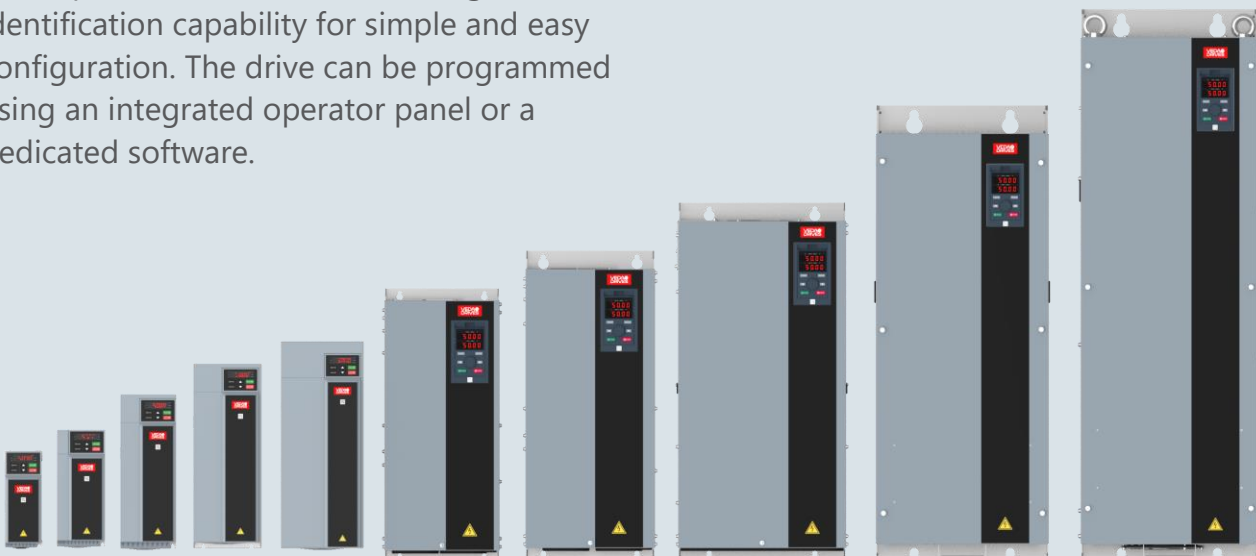

VEDA-IN RD SERIES – Advantages and benefits



Service

VEDA-IN DRIVES offers network of certified partners for RD SERIES service and sale in the Balkan region and European Union. We and our partners provide warranty and post-warranty service of VEDA-IN RD series in the largest cities.



Own R&D center

The development of new products by VEDA-IN DRIVES engineers was based on the operating experience of various variable frequency drives, feedback from partners and customers and the technical capabilities of suppliers. VEDA-IN DRIVES adheres to responsive approach and our engineers can modify the product functionality to meet diverse application requirements.

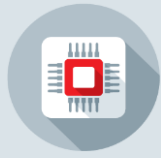

A wide range of products designed for specific applications

With dedicated series of VEDA-IN RD series, we bring out technology advantages to various industries, including water supply and wastewater disposal, HVAC, chemical and mining industries, lifts and cranes, shipbuilding, oil and gas production, power generation.



100% focused on RD SERIES

The VEDA-IN DRIVES team has over 15 years of experience in the drive technology market. The company employees are 100% focused on variable frequency drives.



Energy savings up to 50%

Variable frequency drives bring the significant energy savings for pumps and fans. For example, with variable frequency drives energy consumption can be reduced by 2 times by reducing the pump motor speed by 20%!



Product overview

VEDA-IN RD SERIES family includes basic series for basic infrastructure and industry applications. VEDA-IN RD SERIES products are manufactured in fully automated factories under the strict supervision of VEDA-IN DRIVES engineers. All RD series offers a modular design and scalable functionality by using various optional modules.



RD05 Series – versatile and compact-sized drives ranging from 0.75 to 22kW, with overload capacity up to 150%. Suitable for pumps, fans, machines and conveyors.



RD11 Series — dedicated drives ranging from 0.75 to 1120 kW, with overload capacity up to 150%, compatible with various communication protocols. This series supports dedicated functions for pumping and fan applications. Suitable for pumps, fans, fire extinguishing systems.

Modular design

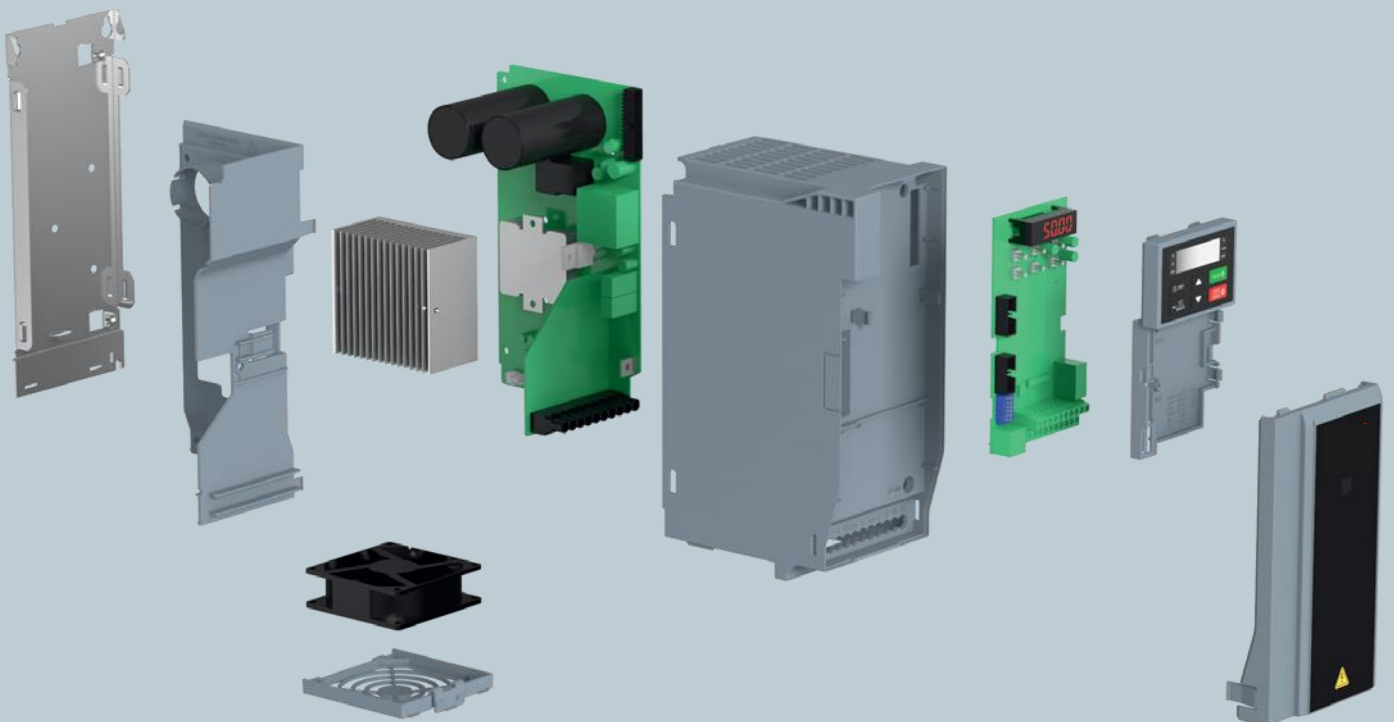

RD05

RD05 Series – versatile variable frequency drives for pump and fan control, including general automation applications.

The drive ranges from 0.75 to 22 kW and can be powered from 1 × 220 V and 3 × 380 V mains. The drive features an integrated RS-485 network interface.

Due to a slim design, these products can be mounted “side by side” without derating.

RD05 drives allow to use motor cable lengths up to 150 m without derating.

A separated cooling system prevents the air flow from passing through the electronic components, thus improving the drive service life. An efficient cooling system allows operation at ambient temperatures up to +50 °C.



RD05

RD05 UNI specifications

Order code	Type code	Voltage, V	Output power, kW	Rated output current, A	Overload current 150%, A	Thermal loss, W	H × W × D, mm
11A00AAA001	RD05-S2-0004-IP20-BU	Input 1×220, output 3×220	0.75	4	6	30	177×65×148
11A00AAA002	RD05-S2-0007-IP20-BU		1.5	7	10.5	60	202×75×163
11A00AAA003	RD05-S2-0010-IP20-BU		2.2	10	15	88	
11A00AAA004	RD05-T4-0003-IP20-BU	Input 3 × 380, output 3 × 380	0.75	3	4.5	30	177×65×148
11A00AAA005	RD05-T4-0004-IP20-BU		1.5	4	6	60	
11A00AAA006	RD05-T4-0005-IP20-BU		2.2	5	7.5	88	
11A00AAA007	RD05-T4-0009-IP20-BU		4	9.5	14.25	160	202×75×163
11A00AAA008	RD05-T4-0013-IP20-BU		5.5	13	19.5	165	
11A00AAA009	RD05-T4-0016-IP20-BU		7.5	17	25.5	225	320×130×161
11A00AAA010	RD05-T4-0025-IP20-BU		11	25	37.5	330	
11A00AAA011	RD05-T4-0032-IP20-BU		15	32	48	450	342,5×170×183
11A00AAA012	RD05-T4-0038-IP20-BU		18.5	38	57	540	
11A00AAA013	RD05-T4-0045-IP20-BU		22	45	67.5	660	

Note.

Overload capacity:

Single phase RD05 series: 150 % — 20 s, 180 % — 0.5 s.

Three phase RD05 series: 150 % — 60 s, 180 % — 5 s, 200 % — 0.5 s.

Includes fixed digital operator panel with potentiometer.

Weight and overall dimensions

Version A1-A2 (0.4–5.5 kW)

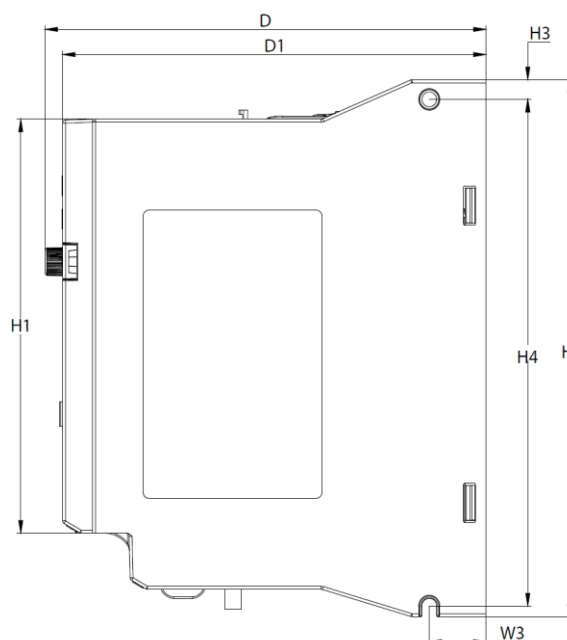
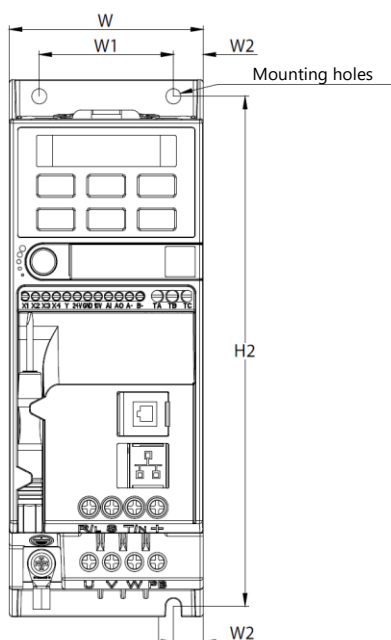

Driver overall dimensions and weight – version A1

Supply voltage, V	Rated power, W	Overall dimensions, mm					Installation dimensions, mm						Fastening	Weight, kg
		W	H	H1	D	D1	W1	W2	H2	W3	H3	H4		
220	0.75	65	177	155	148	142	45	10	168	19	6,5	167	3-M4	0.9
380	0.75													
	1.5													
	2.2													

Driver overall dimensions – version A2

Supply voltage, V	Rated power, W	Overall dimensions, mm					Installation dimensions, mm						Fastening	Weight, kg
		W	H	H1	D	D1	W1	W2	H2	W3	H3	H4		
220	1.5	75	202	180	163	157	55	10	193	19	6,5	192	3-M4	1,9
380	2.2													
	4													
	5.5													

Version A3-A4 (7.5–22 kW)

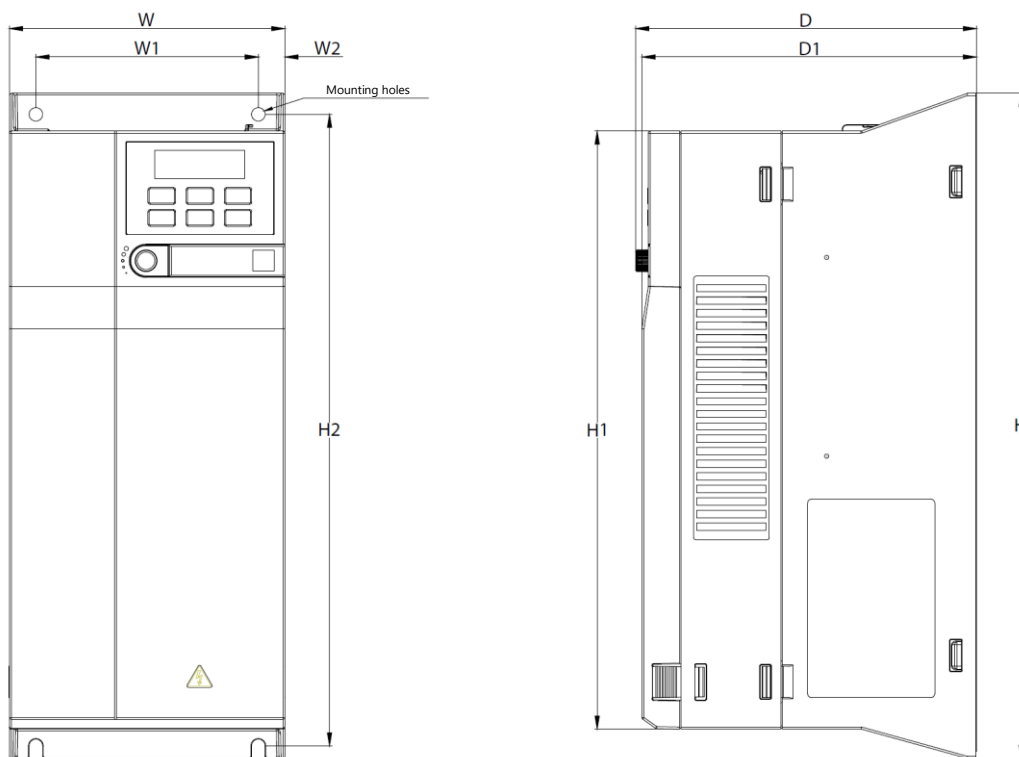

Driver overall dimensions and weight – version A3

Supply voltage, V	Rated power, W	Overall dimensions, mm					Installation dimensions, mm			Fastening	Weight, kg
		W	H	H1	D	D1	W1	W2	H2		
380	7.5	130	320	286	161	158	105	12.5	302	3-M5	3.5
	11										

Driver overall dimensions and weight – version A4

Supply voltage, V	Rated power, W	Overall dimensions, mm					Installation dimensions, mm			Fastening	Weight, kg
		W	H	H1	D	D1	W1	W2	H2		
380	15	170	342.5	303.5	183	180	145	12.5	326.5	4-M5	6
	18.5										
	22										

Product code for ordering

RD05-TX-XXXX-IP20-BU		
RD05	Product series	
TX	Voltage class	
	S2	1 × 220 V
	T4	3 × 380 V
XXXX	Rated current, A	
IP20	Protection class	
	IP20	
BU	Brake unit	
	BU	Built-in

Options for RD05 drives

Order code	Description
11A00PAC001	External digital remote control keyboard with two-line display
11A00PAC009	External digital remote control keyboard with single-line display
11A00PAC010	External graphical keyboard
11A20YAA001	Extended warranty 36 months
11A20YAA002	Extended warranty 48 months
11A20YAA003	Extended warranty 60 months

Wiring diagram – control cables

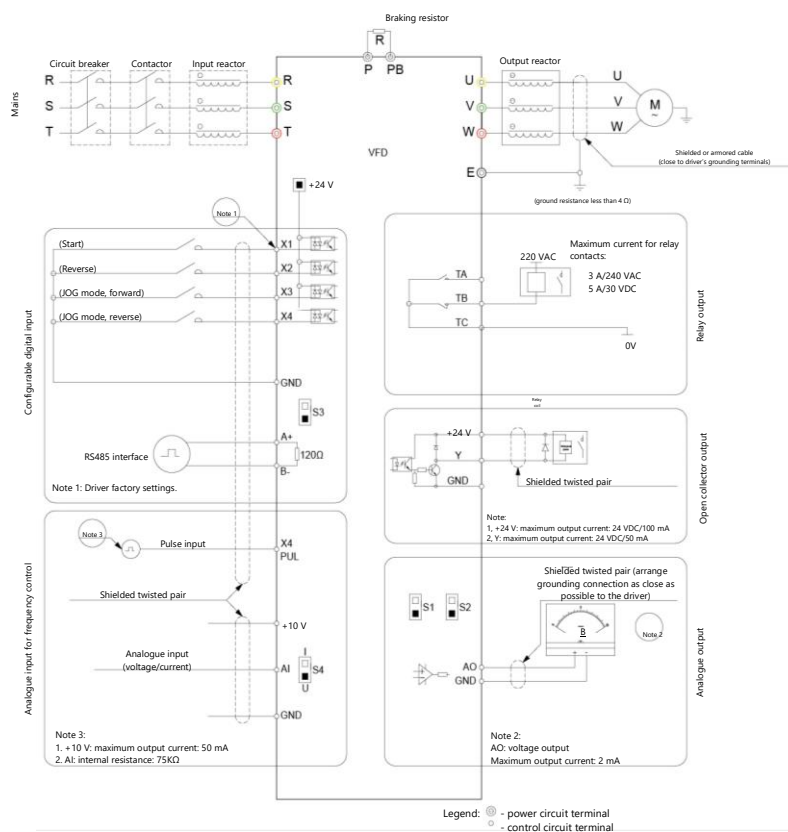

RD05 specifications

Power supply (R, S, T/L, N)	
Voltage range, V	S2: 1×220; T4: 3×380
Frequency, Hz	50/60 ±5 %
Deviations, %	Voltage unbalance <3 Distortion level per IEC61800-2
Power factor (cos φ)	≥ 0.94 (with DC reactor)
Inverter efficiency, %	≥ 96
Output (U, V, W)	
Output voltage	0–100 % of input voltage (for normal conditions, error < 5%)
Output frequency, Hz	0–200 (VVC+ mode), 0–299 (U/f mode)
Output frequency control accuracy, %	± 0.5 of maximum frequency value
Current overload capacity from rated value	1×220 V drive: 150% for 20 s, 180% for 5 s. 3 × 380 V drive: 150% for 1 min, 180% for 5 s, 200% for 0.5 s
Basic control parameters	
Motor type	Asynchronous motor, permanent magnet synchronous motor (PMSM)
Motor control mode	U/f without feedback, vector control without position sensor
Modulation type	Space vector pulse width modulation (SVPWM)
PWM frequency, kHz	1–16
Speed control range	Open loop vector control: 1:100 at rated load
Speed control accuracy in steady mode	Open loop vector control: ≤ 2% of rated synchronous speed
Starting torque	Open loop vector control: 150% of rated torque at 0.5 Hz
Response to torque changes	Open loop vector control: < 20 ms
Frequency control accuracy	Digital input: ±0.01% of maximum frequency. Analog input: ±0.2% of maximum frequency
Frequency control increment	Digital input: 0.01 Hz Analog input: 0.05% of maximum frequency
Key Functions	
DC braking	Start frequency: 0–50 Hz Braking time: 0.1–60 s Braking current: up to 150% of rated current
Torque compensation	Auto mode: up to 100%. Manual mode: up to 30%
U/f curve	Four types: linear curve, self-adapting curve, torque reduction curve (second control zone from 1.1 to 2.0 power), quadratic curve
Acceleration and deceleration curves	Two types: linear curve, S-shaped acceleration and deceleration curves. Four sets for acceleration and deceleration times; time step 0.01 s, maximum – 650 s
Rated output voltage	Selectable between 50 and 100% of input voltage. With supply voltage compensation function: 100%
Automatic voltage regulation	Automatic output voltage regulation for supply voltage fluctuations
Auto energy saving function	Automatic current limiting to prevent failures due to overcurrent
Standard functions	PID control, speed tracking and auto-start after power failure, jump frequencies, upper and lower frequency limits, preset speeds, RS-485, analog output, pulse frequency output
Frequency command inputs	Digital command by operator panel, panel potentiometer, analogue command (voltage/current), communication bus, digital preset speed commands by digital inputs, main and standby control station (various switchover types)
Inputs	1 x analog voltage/current input, 4 x digital inputs
START command inputs	Operator panel, digital input, communication bus
Input commands	Start, Stop, Forward/Reverse, Jog, Multi-speed, Coasting, Reset, Acceleration/Deceleration, control source selection, remote alarm
Outputs	1 x analog current/voltage output, 1 x digital output, 1 x relay
Unshielded cable length, m	50 - up to 4 kW, 70-135 from 5.5 to 18.5 kW, 150 — 18.5 kW max.
Display	Built-in digital single line display, optional remote digital two-line display (parameter copy function supported)
Environmental	
Housing	IP20 (forced air cooling)
Maximum altitude level, m	1000 (for higher level, performance derating by 1% for each 100 m)
Operational temperature, °C	–10 ... +50 Derating above +40 °C. +60 °C max for reduced load conditions
Relative humidity, %	5–95 (no condensation)
Vibration, g	0.6 (5.9 m/s ²) for vibration range 9–200 Hz
Storage temperature, °C	–40 ... +60
Installation	Wall-mounting or panel-mounting

RD05

RD11

RD11 Series — variable frequency drives for HVAC/R systems, piston, screw and scroll compressors, pumps and general industrial applications, including heavy duty starts. The drive ranges from 0.75 to 1120 kW and can be powered from 1 x 220 V, 3 x 380 V, 3 x 660 V, 3 x 1140 V mains.

The drive features an integrated RS-485 network interface. RD11 drive supports both asynchronous and synchronous motors.

The drive offers a modular design and scalable functionality by using various optional modules.

RD11 drives allow to use motor cable lengths up to 150 m without derating.

With an automatic motor identification (with/without motor rotation), products of this series provide for more accurate identification of motor parameters.

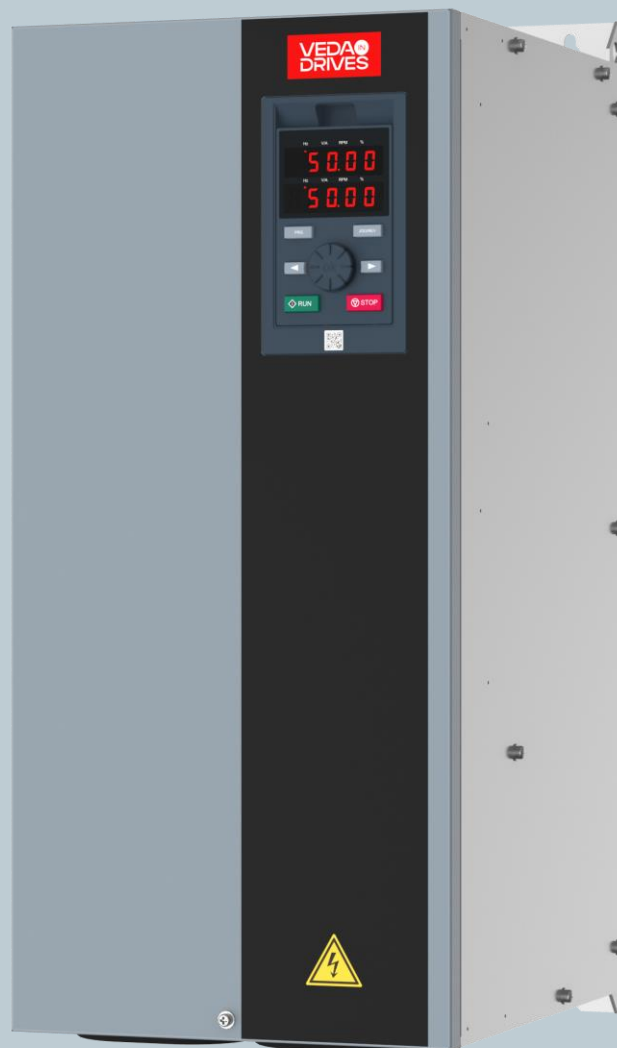

Specifications for RD11 UNI with low overload capacity, 3 × 380 V

Order code	Product code	Output power, kW	Rated output current, A	Overload current 120%, A	Braking unit	DC choke	Thermal loss, W	H × W × D, mm
11A00AAC001	RD11-T4-0003-LO-IP20-BU	0.75	3	3.6	Built-in	External	22.5	204x80x155
11A00AAC002	RD11-T4-0004-LO-IP20-BU	1.5	4	4.8			45	
11A00AAC003	RD11-T4-0006-LO-IP20-BU	2.2	6	7.2			66	
11A00AAC004	RD11-T4-0013-LO-IP20-BU	5.5	13	15.6			165	245x100x155
11A00AAC005	RD11-T4-0017-LO-IP20-BU	7.5	17	20.4			225	
11A00AAC006	RD11-T4-0025-LO-IP20-BU	11	25	30			330	323x116x175
11A00AAC007	RD11-T4-0032-LO-IP20-BU	15	32	38.4			450	
11A00AAC008	RD11-T4-0038-LO-IP20-BU	18	38	45.6			540	383 × 142 × 225
11A00AAC009	RD11-T4-0045-LO-IP20-BU	22	45	54			660	
11A00AAC010	RD11-T4-0060-LO-IP20-BU	30	60	72			900	433.5x172x225
11A00AAC011	RD11-T4-0075-LO-IP20-N	37	75	90			1110	
11A00AAC012	RD11-T4-0090-LO-IP20-N	45	90	108			1215	
11A00AAC013	RD11-T4-0110-LO-IP20-N	55	110	132			1375	558x249.4x310
11A00AAC014	RD11-T4-0150-LO-IP20-N	75	150	180			1650	
11A00AAC015	RD11-T4-0180-LO-IP20-N	90	180	216			1800	638x279.4x350
11A00AAC016	RD11-T4-0210-LO-IP20-N	110	210	252			2200	
11A00AAC017	RD11-T4-0250-LO-IP20-N	132	250	300			2640	738x359.4x405
11A00AAC028	RD11-T4-0310-LO-IP20-N-DC	160	310	372	3200			
11A00AAC029	RD11-T4-0340-LO-IP20-N-DC	185	340	408	3700	940x369.4x480		
11A00AAC030	RD11-T4-0380-LO-IP20-N-DC	200	380	456	4000			
11A00AAC031	RD11-T4-0415-LO-IP20-N-DC	220	415	498	4400			
11A00AAC032	RD11-T4-0470-LO-IP20-N-DC	250	470	564	5000	1140x379.4x545		
11A00AAC033	RD11-T4-0520-LO-IP20-N-DC	280	510	612	5600			
11A00AAC034	RD11-T4-0600-LO-IP20-N-DC	315	600	720	6300	1250x404.4x545		
11A00AAC035	RD11-T4-0680-LO-IP20-N-DC	355	670	804	7100			
11A00AAC036	RD11-T4-0750-LO-IP20-N-DC	400	750	900	8000	1400x469.7x545		
11A00AAC037	RD11-T4-0810-LO-IP20-N-DC	450	810	972	9000			
11A00AAC038	RD11-T4-0870-LO-IP20-N-DC	500	860	1032	10000	2198x1201x798		
11A00AAC039	RD11-T4-0950-LO-IP20-N-DC	560	990	1188	11200			
11A00AAC040	RD11-T4-1200-LO-IP20-N-DC	630	1200	1440	12600	2198x1201x798		
11A00AAC041	RD11-T4-1340-LO-IP20-N-DC	710	1340	1608	14200			
11A00AAC042	RD11-T4-1500-LO-IP20-N-DC	800	1500	1800	16000	2198x1201x798		
11A00AAC043	RD11-T4-1620-LO-IP20-N-DC	900	1620	1944	18000			
11A00AAC044	RD11-T4-1720-LO-IP20-N-DC	1000	1720	2064	20000	2198x1201x798		
11A00AAC045	RD11-T4-1980-LO-IP20-N-DC	1120	1980	2376	22400			

Note. Includes an integrated digital operator panel.

Specifications for RD11 UNI with low overload capacity and integrated brake unit, 3 × 380 V

Order code	Product code	Output power, kW	Rated output current, A	Overload current 120%, A	Braking unit	DC choke	Thermal loss, W	H × W × D, mm
11A00AAC001	RD11-T4-0003-LO-IP20-BU	0.75	3	3.6	Built-in	External	22.5	204x80x155
11A00AAC002	RD11-T4-0004-LO-IP20-BU	1.5	4	4.8			45	
11A00AAC003	RD11-T4-0006-LO-IP20-BU	2.2	6	7.2			66	
11A00AAC004	RD11-T4-0013-LO-IP20-BU	5.5	13	15.6			165	245x100x155
11A00AAC005	RD11-T4-0017-LO-IP20-BU	7.5	17	20.4			225	
11A00AAC006	RD11-T4-0025-LO-IP20-BU	11	25	30			330	323x116x175
11A00AAC007	RD11-T4-0032-LO-IP20-BU	15	32	38.4			450	
11A00AAC008	RD11-T4-0038-LO-IP20-BU	18	38	45.6			540	383 × 142 × 225
11A00AAC009	RD11-T4-0045-LO-IP20-BU	22	45	54			660	
11A00AAC010	RD11-T4-0060-LO-IP20-BU	30	60	72			900	433.5x172x225
11A00AAC018	RD11-T4-0075-LO-IP20-BU	37	75	90			1110	
11A00AAC019	RD11-T4-0090-LO-IP20-BU	45	90	108			1215	558x249.4x310
11A00AAC020	RD11-T4-0110-LO-IP20-BU	55	110	132			1375	
11A00AAC021	RD11-T4-0150-LO-IP20-BU	75	150	180			1650	638x279.4x350
11A00AAC022	RD11-T4-0180-LO-IP20-BU	90	180	216			1800	

Note. Includes an integrated digital operator panel.

Specifications for RD11 UNI with low overload capacity and integrated DC choke, 3 × 380 V

Order code	Product code	Output power, kW	Rated output current, A	Overload current 120%, A	Braking unit	DC choke	Thermal loss, W	H × W × D, mm
11A00AAC023	RD11-T4-0110-LO-IP20-N-DC	55	110	132	External	Built-in	1375	558x249,4x310
11A00AAC024	RD11-T4-0150-LO-IP20-N-DC	75	150	180			1650	
11A00AAC025	RD11-T4-0180-LO-IP20-N-DC	90	180	216			1800	
11A00AAC026	RD11-T4-0210-LO-IP20-N-DC	110	210	252			2200	638x279,4x350
11A00AAC027	RD11-T4-0250-LO-IP20-N-DC	132	250	300			2640	
11A00AAC028	RD11-T4-0310-LO-IP20-N-DC	160	310	372			3200	738x359,4x405
11A00AAC029	RD11-T4-0340-LO-IP20-N-DC	185	340	408			3700	
11A00AAC030	RD11-T4-0380-LO-IP20-N-DC	200	380	456			4000	940x369,4x480
11A00AAC031	RD11-T4-0415-LO-IP20-N-DC	220	415	498			4400	
11A00AAC032	RD11-T4-0470-LO-IP20-N-DC	250	470	564			5000	1140x379,4x545
11A00AAC033	RD11-T4-0520-LO-IP20-N-DC	280	510	612			5600	
11A00AAC034	RD11-T4-0600-LO-IP20-N-DC	315	600	720			6300	
11A00AAC035	RD11-T4-0680-LO-IP20-N-DC	355	670	804			7100	1250x404,4x545
11A00AAC036	RD11-T4-0750-LO-IP20-N-DC	400	750	900			8000	
11A00AAC037	RD11-T4-0810-LO-IP20-N-DC	450	810	972			9000	1400x469,7x545
11A00AAC038	RD11-T4-0870-LO-IP20-N-DC	500	860	1032			10000	
11A00AAC039	RD11-T4-0950-LO-IP20-N-DC	560	990	1188			11200	
11A00AAC040	RD11-T4-1200-LO-IP20-N-DC	630	1200	1440			12600	2198x1201x798
11A00AAC041	RD11-T4-1340-LO-IP20-N-DC	710	1340	1608			14200	
11A00AAC042	RD11-T4-1500-LO-IP20-N-DC	800	1500	1800			16000	
11A00AAC043	RD11-T4-1620-LO-IP20-N-DC	900	1620	1944			18000	
11A00AAC044	RD11-T4-1720-LO-IP20-N-DC	1000	1720	2064			20000	
11A00AAC045	RD11-T4-1980-LO-IP20-N-DC	1120	1980	2376			22400	

Note. Includes an integrated digital operator panel.

Specifications for RD11 UNI with low overload capacity, integrated brake unit and integrated DC choke, 3 × 380 V

Order code	Product code	Output power, kW	Rated output current, A	Overload current 150%, A	Braking unit	DC choke	H × W × D, mm
11A00AAC454	RD11-T4-0110-LO-IP20-BU-DC	55	110	132	Built-in	Built-in	558x249,4x310
11A00AAC455	RD11-T4-0150-LO-IP20-BU-DC	75	150	180	Built-in	Built-in	
11A00AAC456	RD11-T4-0180-LO-IP20-BU-DC	90	180	216	Built-in	Built-in	
11A00AAC457	RD11-T4-0210-LO-IP20-BU-DC	110	210	252	Built-in	Built-in	638x279,4x350
11A00AAC458	RD11-T4-0250-LO-IP20-BU-DC	132	250	300	Built-in	Built-in	

Note. Includes an integrated digital operator panel.

Specifications for RD11 UNI with high overload capacity, 3 × 380 V

Order code	Product code	Output power, kW	Rated output current, A	Overload current 150%, A	Braking unit	DC choke	Thermal loss, W	H × W × D, mm
11A00AAC101	RD11-T4-0003-HO-IP20-BU	0.75	3	4.5	Built-in		22,5	204x80x155
11A00AAC102	RD11-T4-0004-HO-IP20-BU	1.5	4	6			45	
11A00AAC103	RD11-T4-0006-HO-IP20-BU	2.2	6	9			66	
11A00AAC104	RD11-T4-0010-HO-IP20-BU	4	10	15			120	245x100x155
11A00AAC105	RD11-T4-0013-HO-IP20-BU	5.5	13	19.5			165	
11A00AAC106	RD11-T4-0017-HO-IP20-BU	7.5	17	25.5			225	323x116x175
11A00AAC107	RD11-T4-0025-HO-IP20-BU	11	25	37.5			330	
11A00AAC108	RD11-T4-0032-HO-IP20-BU	15	32	48			450	383 × 142 × 225
11A00AAC109	RD11-T4-0038-HO-IP20-BU	18	38	57			540	
11A00AAC110	RD11-T4-0045-HO-IP20-BU	22	45	67.5			660	
11A00AAC111	RD11-T4-0060-HO-IP20-N	30	60	90			900	433,5x172x225
11A00AAC112	RD11-T4-0075-HO-IP20-N	37	75	112.5			1110	
11A00AAC113	RD11-T4-0090-HO-IP20-N	45	90	135			1215	558x249,4x310
11A00AAC114	RD11-T4-0110-HO-IP20-N	55	110	165			1375	
11A00AAC115	RD11-T4-0150-HO-IP20-N	75	150	225	1650	638x279,4x350		
11A00AAC116	RD11-T4-0180-HO-IP20-N	90	180	270	1800			
11A00AAC117	RD11-T4-0210-HO-IP20-N	110	210	315	2200	738x359,4x405		
11A00AAC128	RD11-T4-0250-HO-IP20-N-DC	132	250	375	2640			
11A00AAC129	RD11-T4-0310-HO-IP20-N-DC	160	310	465	3200			
11A00AAC130	RD11-T4-0340-HO-IP20-N-DC	185	340	510	3700		940x369,4x480	
11A00AAC131	RD11-T4-0380-HO-IP20-N-DC	200	380	570	4000			
11A00AAC132	RD11-T4-0415-HO-IP20-N-DC	220	415	622.5	4400		1140x379,4x545	
11A00AAC133	RD11-T4-0470-HO-IP20-N-DC	250	470	705	5000			
11A00AAC134	RD11-T4-0510-HO-IP20-N-DC	280	510	765	5600			
11A00AAC135	RD11-T4-0600-HO-IP20-N-DC	315	600	900	6300		1250x404,4x545	
11A00AAC136	RD11-T4-0670-HO-IP20-N-DC	355	670	1005	7100			
11A00AAC137	RD11-T4-0750-HO-IP20-N-DC	400	750	1125	8000		1400x469,7x545	
11A00AAC138	RD11-T4-0810-HO-IP20-N-DC	450	810	1215	9000			
11A00AAC139	RD11-T4-0860-HO-IP20-N-DC	500	860	1290	10000		2198x1201x798	
11A00AAC140	RD11-T4-0990-HO-IP20-N-DC	560	990	1485	11200			
11A00AAC141	RD11-T4-1200-HO-IP20-N-DC	630	1200	1440	12600			
11A00AAC142	RD11-T4-1340-HO-IP20-N-DC	710	1340	1608	14200			
11A00AAC143	RD11-T4-1500-HO-IP20-N-DC	800	1500	1800	16000			
11A00AAC144	RD11-T4-1620-HO-IP20-N-DC	900	1620	1944	18000			
11A00AAC145	RD11-T4-1720-HO-IP20-N-DC	1000	1720	2064	20000			
11A00AAC146	RD11-T4-1980-HO-IP20-N-DC	1120	1980	2376	22400			

Note. Includes an integrated digital operator panel.

Specifications for RD11 UNI with high overload capacity and integrated brake unit, 3 × 380 V

Order code	Product code	Output power, kW	Rated output current, A	Overload current 150%, A	Braking unit	DC choke	Thermal loss, W	H × W × D, mm
11A00AAC101	RD11-T4-0003-HO-IP20-BU	0.75	3	4.5	Built-in	External	22,5	204x80x155
11A00AAC102	RD11-T4-0004-HO-IP20-BU	1.5	4	6			45	
11A00AAC103	RD11-T4-0006-HO-IP20-BU	2.2	6	9			66	
11A00AAC104	RD11-T4-0010-HO-IP20-BU	4	10	15			120	245x100x155
11A00AAC105	RD11-T4-0013-HO-IP20-BU	5.5	13	19.5			165	
11A00AAC106	RD11-T4-0017-HO-IP20-BU	7.5	17	25.5			225	323x116x175
11A00AAC107	RD11-T4-0025-HO-IP20-BU	11	25	37.5			330	
11A00AAC108	RD11-T4-0032-HO-IP20-BU	15	32	48			450	383 × 142 × 225
11A00AAC109	RD11-T4-0038-HO-IP20-BU	18	38	57			540	
11A00AAC110	RD11-T4-0045-HO-IP20-BU	22	45	67.5			660	
11A00AAC118	RD11-T4-0060-HO-IP20-BU	30	60	90			900	433,5x172x225
11A00AAC119	RD11-T4-0075-HO-IP20-BU	37	75	112.5			1110	
11A00AAC120	RD11-T4-0090-HO-IP20-BU	45	90	135			1215	558x249,4x310
11A00AAC121	RD11-T4-0110-HO-IP20-BU	55	110	165			1375	
11A00AAC122	RD11-T4-0150-HO-IP20-BU	75	150	225	1650			

Note. Includes an integrated digital operator panel.

Specifications for RD11 UNI with high overload capacity and integrated DC choke, 3 × 380 V

Order code	Product code	Output power, kW	Rated output current, A	Overload current 150%, A	Braking unit	DC choke	Thermal loss, W	H × W × D, mm
11A00AAC123	RD11-T4-0090-HO-IP20-N-DC	45	90	135	External	Built-in	1215	558x249,4x310
11A00AAC124	RD11-T4-0110-HO-IP20-N-DC	55	110	132			1375	
11A00AAC125	RD11-T4-0150-HO-IP20-N-DC	75	150	180			1650	
11A00AAC126	RD11-T4-0180-HO-IP20-N-DC	90	180	216			1800	638x279,4x350
11A00AAC127	RD11-T4-0210-HO-IP20-N-DC	110	210	252			2200	
11A00AAC128	RD11-T4-0250-HO-IP20-N-DC	132	250	375			2640	738x359,4x405
11A00AAC129	RD11-T4-0310-HO-IP20-N-DC	160	310	465			3200	
11A00AAC130	RD11-T4-0340-HO-IP20-N-DC	185	340	510			3700	940x369,4x480
11A00AAC131	RD11-T4-0380-HO-IP20-N-DC	200	380	570			4000	
11A00AAC132	RD11-T4-0415-HO-IP20-N-DC	220	415	622,5			4400	1140x379,4x545
11A00AAC133	RD11-T4-0470-HO-IP20-N-DC	250	470	705			5000	
11A00AAC134	RD11-T4-0510-HO-IP20-N-DC	280	510	765			5600	
11A00AAC135	RD11-T4-0600-HO-IP20-N-DC	315	600	900			6300	1250x404,4x545
11A00AAC136	RD11-T4-0670-HO-IP20-N-DC	355	670	1005			7100	
11A00AAC137	RD11-T4-0750-HO-IP20-N-DC	400	750	1125			8000	1400x469,7x545
11A00AAC138	RD11-T4-0810-HO-IP20-N-DC	450	810	1215			9000	
11A00AAC139	RD11-T4-0860-HO-IP20-N-DC	500	860	1290			10000	2198x1201x798
11A00AAC140	RD11-T4-0990-HO-IP20-N-DC	560	990	1485			11200	
11A00AAC141	RD11-T4-1200-HO-IP20-N-DC	630	1200	1440			12600	
11A00AAC142	RD11-T4-1340-HO-IP20-N-DC	710	1340	1608			14200	18000
11A00AAC143	RD11-T4-1500-HO-IP20-N-DC	800	1500	1800			16000	
11A00AAC144	RD11-T4-1620-HO-IP20-N-DC	900	1620	1944			18000	20000
11A00AAC145	RD11-T4-1720-HO-IP20-N-DC	1000	1720	2064			20000	
11A00AAC146	RD11-T4-1980-HO-IP20-N-DC	1120	1980	2376			22400	

Note. Includes an integrated digital operator panel.

Specifications for RD11 UNI with high overload capacity, integrated brake unit and integrated DC choke, 3 × 380 V

Order code	Product code	Output power, kW	Rated output current, A	Overload current 150%, A	Braking unit	DC choke	H × W × D, mm
11A00AAC449	RD11-T4-0090-HO-IP20-BU-DC	45	90	135	Built-in	Built-in	558x249,4x310
11A00AAC450	RD11-T4-0110-HO-IP20-BU-DC	55	110	165	Built-in	Built-in	
11A00AAC451	RD11-T4-0150-HO-IP20-BU-DC	75	150	225	Built-in	Built-in	
11A00AAC452	RD11-T4-0180-HO-IP20-BU-DC	90	180	270	Built-in	Built-in	
11A00AAC453	RD11-T4-0210-HO-IP20-BU-DC	110	210	315	Built-in	Built-in	638x279,4x350

Note. Includes an integrated digital operator panel.

Specifications for RD11 UNI with high overload capacity, 1×220 V input, 3×220 V output

Order code	Product code	Output power, kW	Rated output current, A	Overload current 150%, A	Braking unit	DC choke	Thermal loss, W	H × W × D, mm
11A00AAC459	RD11-S2-0004-HO-IP20-BU	0,75	4	6	Built-in	External	22,5	204x80x155
11A00AAC460	RD11-S2-0007-HO-IP20-BU	1,5	7	10,5			45	
11A00AAC461	RD11-S2-0010-HO-IP20-BU	2,2	10	15			66	245x100x155
11A00AAC462	RD11-S2-0016-HO-IP20-BU	4	16	24			120	
11A00AAC463	RD11-S2-0020-HO-IP20-BU	5,5	20	30			165	323x116x175
11A00AAC464	RD11-S2-0030-HO-IP20-BU	7,5	30	45			225	383x142x225
11A00AAC465	RD11-S2-0042-HO-IP20-BU	11	42	63			330	

Note. Includes an integrated digital operator panel.

Specifications for RD11 UNI with low overload capacity, 3 × 660 V

Order code	Product code	Output power, kW	Rated output current, A	Overload current 120%, A	Braking unit	DC choke	H × W × D, mm
11A00AAC401	RD11-T6-0035-LO-IP20-N	30	35	42	External	External	558x249,4x310
11A00AAC402	RD11-T6-0045-LO-IP20-N	37	45	54		External	
11A00AAC403	RD11-T6-0052-LO-IP20-N	45	52	62.4		External	
11A00AAC404	RD11-T6-0063-LO-IP20-N	55	63	75.6		External	
11A00AAC405	RD11-T6-0086-LO-IP20-N	75	86	103.2		External	
11A00AAC406	RD11-T6-0098-LO-IP20-N	90	98	117.6		External	
11A00AAC407	RD11-T6-0121-LO-IP20-N	110	121	145.2		External	
11A00AAC408	RD11-T6-0150-LO-IP20-N	132	150	180		External	
11A00AAC409	RD11-T6-0175-LO-IP20-N-DC	160	175	210		Built-in	738x359,4x405
11A00AAC410	RD11-T6-0198-LO-IP20-N-DC	185	198	237.6		Built-in	
11A00AAC411	RD11-T6-0218-LO-IP20-N-DC	200	218	261.6		Built-in	940x369,4x480
11A00AAC412	RD11-T6-0235-LO-IP20-N-DC	220	235	282		Built-in	
11A00AAC413	RD11-T6-0270-LO-IP20-N-DC	250	270	324		Built-in	
11A00AAC414	RD11-T6-0330-LO-IP20-N-DC	280	330	396		Built-in	1140x379,4x545
11A00AAC415	RD11-T6-0345-LO-IP20-N-DC	315	345	414		Built-in	
11A00AAC416	RD11-T6-0380-LO-IP20-N-DC	355	380	456		Built-in	1250x404,4x545
11A00AAC417	RD11-T6-0430-LO-IP20-N-DC	400	430	516		Built-in	
11A00AAC418	RD11-T6-0466-LO-IP20-N-DC	450	466	559.2		Built-in	1400x469,7x545
11A00AAC419	RD11-T6-0540-LO-IP20-N-DC	500	540	648		Built-in	
11A00AAC420	RD11-T6-0600-LO-IP20-N-DC	560	600	720		Built-in	
11A00AAC421	RD11-T6-0690-LO-IP20-N-DC	630	690	828		Built-in	

Note. Includes an integrated digital operator panel.

Specifications for RD11 UNI with high overload capacity, 3 × 660 V

Order code	Product code	Output power, kW	Rated output current, A	Overload current 150%, A	Braking unit	DC choke	H × W × D, mm
11A00AAC301	RD11-T6-0028-HO-IP20-N	22	28	42	External	External	558x249,4x310
11A00AAC302	RD11-T6-0035-HO-IP20-N	30	35	52.5		External	
11A00AAC303	RD11-T6-0045-HO-IP20-N	37	45	67.5		External	
11A00AAC304	RD11-T6-0052-HO-IP20-N	45	52	78		External	
11A00AAC305	RD11-T6-0063-HO-IP20-N	55	63	94.5		External	
11A00AAC306	RD11-T6-0086-HO-IP20-N	75	86	129		External	
11A00AAC307	RD11-T6-0098-HO-IP20-N	90	98	147		External	
11A00AAC308	RD11-T6-0121-HO-IP20-N	110	121	181.5		External	
11A00AAC309	RD11-T6-0150-HO-IP20-N-DC	132	150	225		Built-in	738x359,4x405
11A00AAC310	RD11-T6-0175-HO-IP20-N-DC	160	175	262.5		Built-in	
11A00AAC311	RD11-T6-0198-HO-IP20-N-DC	185	198	297		Built-in	940x369,4x480
11A00AAC312	RD11-T6-0218-HO-IP20-N-DC	200	218	327		Built-in	
11A00AAC313	RD11-T6-0235-HO-IP20-N-DC	220	235	352.5		Built-in	
11A00AAC314	RD11-T6-0270-HO-IP20-N-DC	250	270	405		Built-in	1140x379,4x545
11A00AAC315	RD11-T6-0330-HO-IP20-N-DC	280	330	495		Built-in	
11A00AAC316	RD11-T6-0345-HO-IP20-N-DC	315	345	517.5		Built-in	1250x404,4x545
11A00AAC317	RD11-T6-0380-HO-IP20-N-DC	355	380	570		Built-in	
11A00AAC318	RD11-T6-0430-HO-IP20-N-DC	400	430	645		Built-in	1400x469,7x545
11A00AAC319	RD11-T6-0466-HO-IP20-N-DC	450	466	699		Built-in	
11A00AAC320	RD11-T6-0540-HO-IP20-N-DC	500	540	810		Built-in	
11A00AAC321	RD11-T6-0600-HO-IP20-N-DC	560	600	900		Built-in	2198x1201x798
11A00AAC322	RD11-T6-0690-HO-IP20-N-DC	630	690	1035	Built-in		
11A00AAC323	RD11-T6-0760-HO-IP20-N-DC	710	760	1140	Built-in		
11A00AAC324	RD11-T6-0860-HO-IP20-N-DC	800	860	1290	Built-in		
11A00AAC325	RD11-T6-0932-HO-IP20-N-DC	900	932	1398	Built-in		
11A00AAC326	RD11-T6-1080-HO-IP20-N-DC	1000	1080	1620	Built-in		

Note. Includes an integrated digital operator panel.

Weight and overall dimensions

Version B1-B3 (0.75 – 11 kW)

HO - high overload capacity, LO - low overload capacity

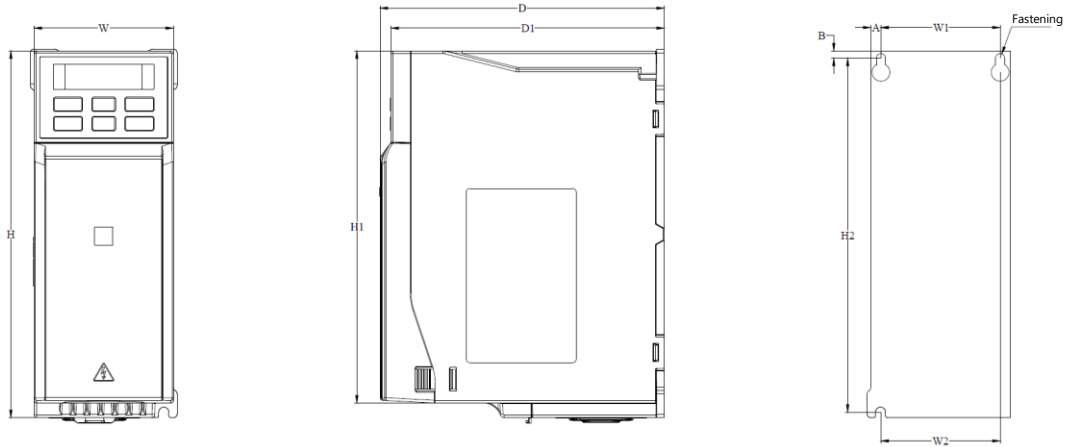

Driver overall dimensions and weight – version B1

Supply voltage, V	Rated power – HO (LO), kW	Overall dimensions, mm					Installation dimensions, mm					Fastening g	Weight, kg
		W	H	H1	D	D1	W1	W2	H2	A	B		
220	0.75	76	200	192	155	149	65	65	193	7.5	5	3-M4	1.3
	1.5												
380	0.75 (0.75)												
	1.5 (1.5)												
	2.2 (2.2)												

Driver overall dimensions and weight – version B2

Supply voltage, V	Rated power – HO (LO), kW	Overall dimensions, mm					Installation dimensions, mm					Fastening	Weight, kg
		W	H	H1	D	D1	W1	W2	H2	A	B		
220	2.2	100	242	231	155	149	84	86.5	231.5	8	5.5	3-M4	1.9
	4												
380	4 (5.5)												
	5.5 (7.5)												

Driver overall dimensions and weight – version B3

Supply voltage, V	Rated power – HO (LO), kW	Overall dimensions, mm					Installation dimensions, mm					Fastening	Weight, kg
		W	H	H1	D	D1	W1	W2	H2	A	B		
220	5.5	116	320	307.5	175	169	98	100	307.5	9	6	M5	3.5
380	7.5 (11)												
	11 (15)												

Version B4-B5 (7.5-37 kW)

HO - high overload capacity, LO - low overload capacity

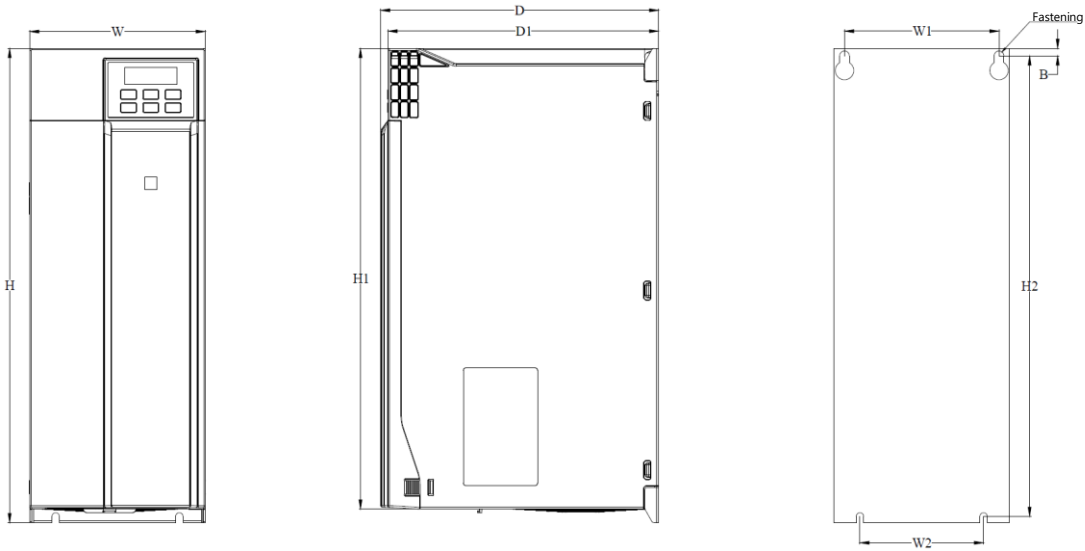

Driver overall dimensions – version B4

Supply voltage, V	Rated power – HO (LO), kW	Overall dimensions, mm					Installation dimensions, mm				Fastenin g	Weight, kg
		W	H	H1	D	D1	W1	W2	H2	V		
220	7.5	142	383	372	225	219	125	100	372	6	4-M5	6
	11											
380	15 (18)	142	383	372	225	219	125	100	372	6	4-M5	6
	18 (22)											
	22 (30)											

Driver overall dimensions – version B5

Supply voltage, V	Rated power – HO (LO), kW	Overall dimensions, mm					Installation dimensions, mm				Fastenin g	Weight, kg
		W	H	H1	D	D1	W1	W2	H2	V		
380	30 (37)	172	430	\	225	219	150	150	416.5	7.5	4-M5	10.9
	37 (45)											

Version B6-B8 (45 – 160 kW)

HO - high overload capacity, LO - low overload capacity

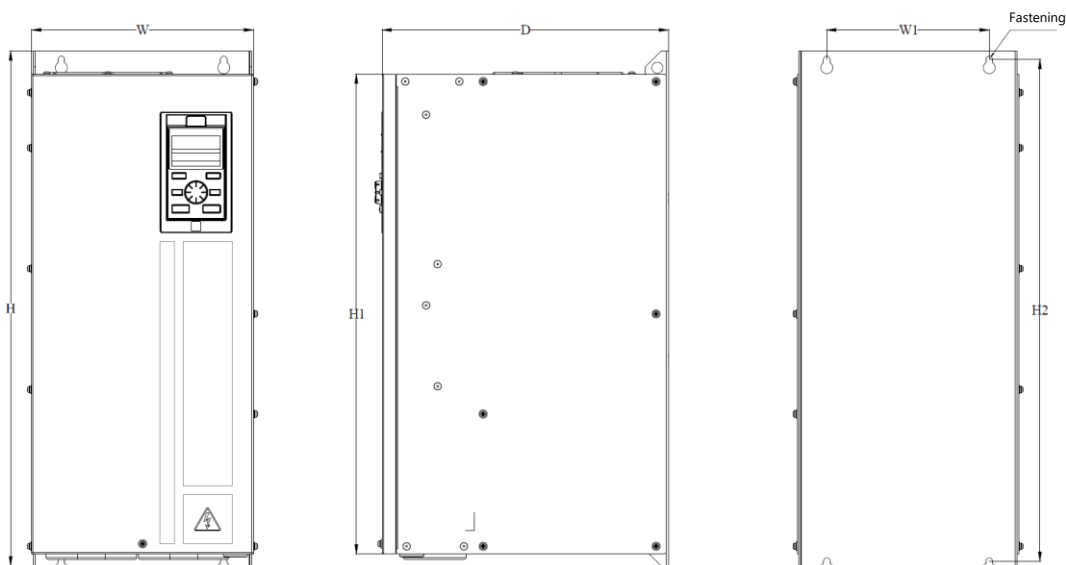

Driver overall dimensions – version B6

Supply voltage, V	Rated power, kW	Overall dimensions, mm				Installation dimensions, mm		Fastening g	Weight, kg
		W	H	H1	D	W2	H2		
380	45 (55)	240	558	520	310	176	544	4-M6	25
	55 (75)								
	75 (90)								
660	22 (30)								
	30 (37)								
	37 (45)								
	45 (55)								
	55 (75)								
75 (90)									

Driver overall dimensions and weight – version B7

Supply voltage, V	Rated power – HO (LO), kW	Overall dimensions, mm				Installation dimensions, mm		Fastening	Weight, kg
		W	H	H1	D	W2	H2		
380	90 (110)	270	638	580	350	195	615	4-M8	35
	110 (132)								
660	90 (110)								
	110 (132)								

Driver overall dimensions and weight – version B8

Supply voltage, V	Rated power – HO (LO), kW	Overall dimensions, mm				Installation dimensions, mm		Fastening g	Weight, kg
		W	H	H1	D	W1	H2		
380	132 (160)	350	738	680	405	220	715	4-M8	63.8
	160 (185)								66.5
660	132 (160)								63.8
	160 (185)								66.5

Version B9-B10 (185 – 280 kW)

HO - high overload capacity, LO - low overload capacity

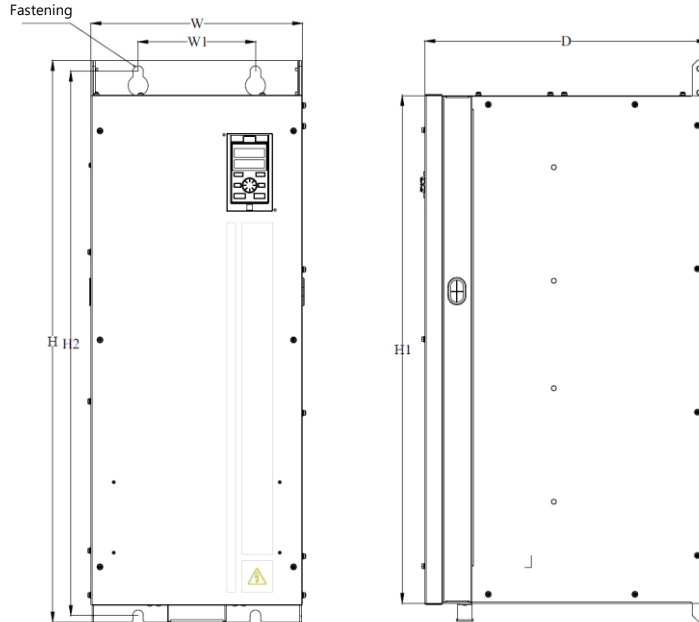

Driver overall dimensions and weight – version B9

Supply voltage, V	Rated power – HO (LO), kW	Overall dimensions, mm				Installation dimensions, mm		Fastening g	Weight, kg
		W	H	H1	D	W1	H2		
380	185 (200)	360	940	850	480	200	910	4-M16	97
	200 (220)								
	220 (250)								
660	185 (200)								
	200 (220)								
	220 (250)								

Driver overall dimensions and weight – version B10

Supply voltage, V	Rated power – HO (LO), kW	Overall dimensions, mm				Installation dimensions, mm		Fastenin g	Weight, kg
		W	H	H1	D	W1	H2		
380	250 (280)	370	1140	1050	545	200	1110	4-M16	126.5
	280 (315)								
660	250 (280)								
	280 (315)								

Version B11 (315 – 400 kW)

HO - high overload capacity, LO - low overload capacity

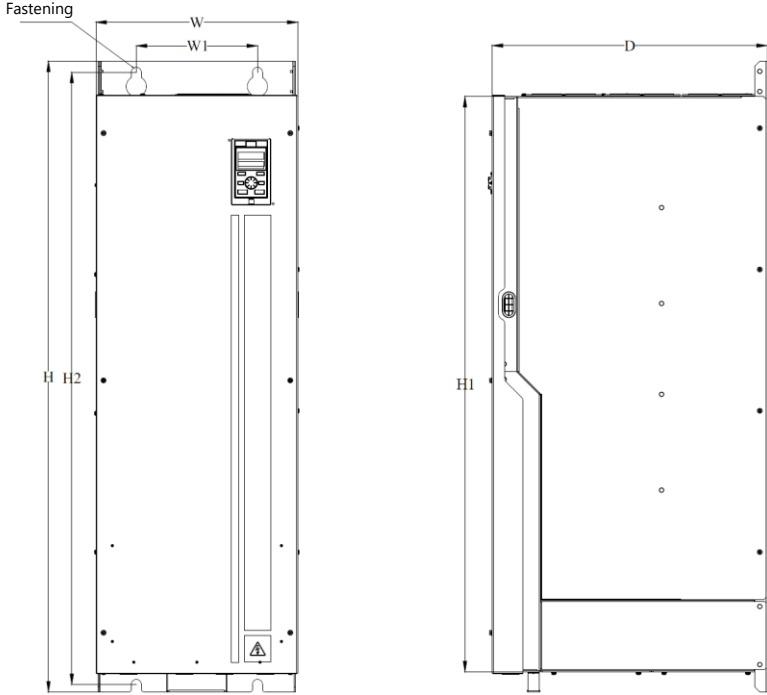

Driver overall dimensions and weight – version B11

Supply voltage, V	Rated power – HO (LO), kW	Overall dimensions, mm				Installation dimensions, mm		Fastenin g	Weight, kg
		W	H	H1	D	W1	H2		
380	315 (355)	400	1250	1143.2	545	240	1213	4-M16	167
	355 (400)								
	400 (450)								
660	315 (355)								
	355 (400)								
	400 (450)								

Version B12 (450–560 kW)

HO - high overload capacity,
LO - low overload capacity

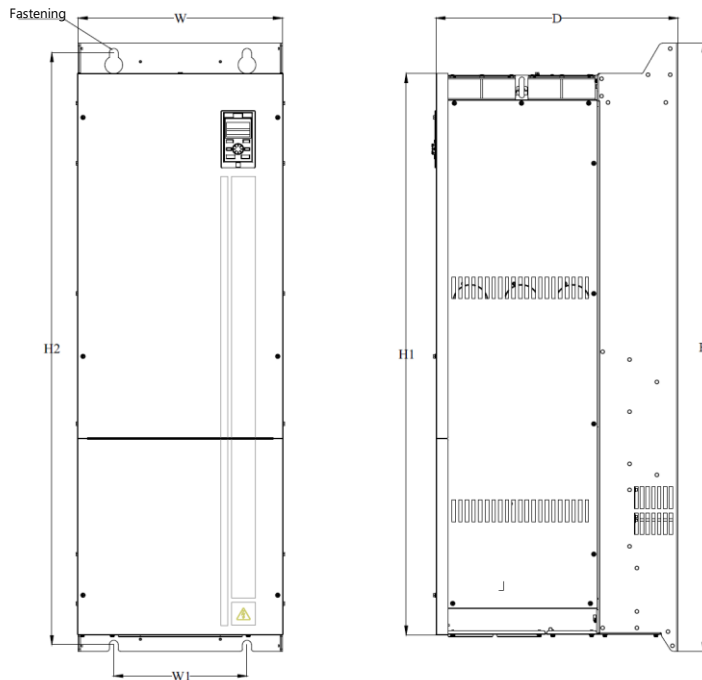

Driver overall dimensions and weight – version B12

Supply voltage, V	Rated power – HO (LO), kW	Overall dimensions, mm				Installation dimensions, mm		Fastening	Weight, kg
		W	H	H1	D	W1	H2		
380	450 (500)	460	1400	1292.5	545	300	1363	4-M16	235
	500 (560)								
	560 (630)								
660	450 (500)								
	500 (560)								
	560 (630)								

Version B13 (630–1120 kW)

HO - high overload capacity, LO - low overload capacity

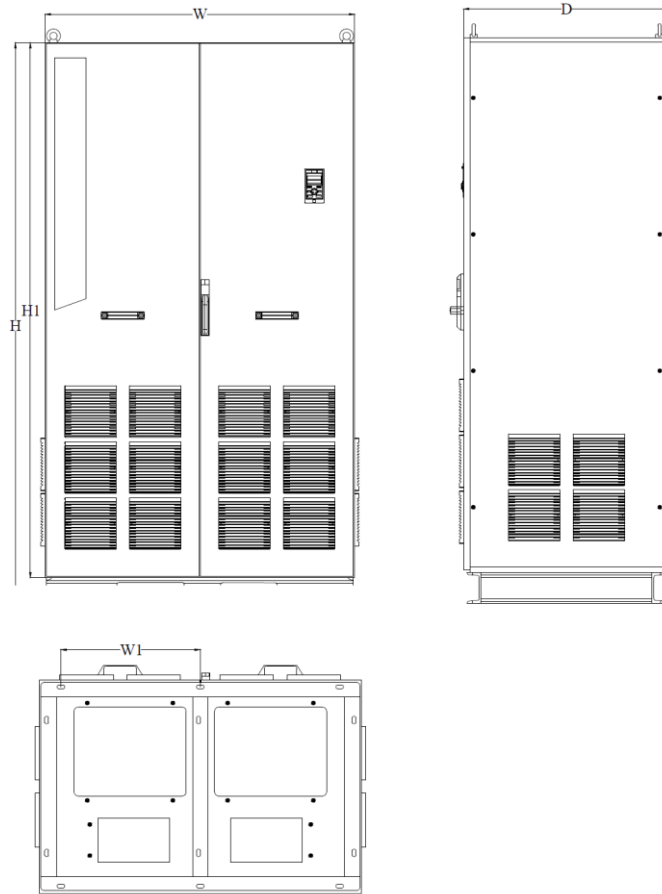

Driver overall dimensions and weight – version B13

Supply voltage, V	Rated power – HO (LO), kW	Overall dimensions, mm				Installation dimensions, mm		Fastening	Weight, kg
		W	H	H1	D	W1	H2		
380	630 (710)	1201.5	2198	2078	798.5	520.5	711	14	485/455
	710 (800)								
	800 (900)								
	900 (1000)								
	1000 (1120)								
660	1120								
	630								
	710								
	800								
	1000								

Product code for ordering

RD11-TX-XXXX-XX-IPXX-BU-DC		
RD11	Product series	
TX	Voltage class	
	S2	1 × 220 V
	T4	3 × 380 V
	T6	3 × 660 V
	T9	3 × 1140 V
XXXX	Rated current, A	
XX	Overload capacity	
	LO	Low overload (120%)
	HO	High overload (150%)
IPXX	Protection class	
	IP20	IP20
	IP54	IP54, metal housing
BU	Brake chopper	
	BU	Built-in
	N	Without brake chopper
DC	Input DC reactor	
	D	Integrated DC reactor
	N	W/o reactor

Options for RD11 drives

Order code	Description
11A00PAC001	External digital remote control keyboard with two-line display
11A00PAC002	RD11 ProfiBus option
11A00PAC003	RD11 ProfiNet option
11A00PAC004	RD11 I/O expansion option (1 x analog output, 4 x digital inputs, 1 x relay output, 1 x digital output, 1 x PT100/PT1000/KTY sensor input)
11A00PAC005	RD11 5V encoder option
11A00PAC006	RD11 12V encoder option
11A00PAC007	RD11 resolver option
11A00PAC008	RD11 CANopen option
11A00PAC014	RD11 EtherCat option
11A00PAC009	External digital remote control keyboard with single-line display
11A00PAC010	External graphical keyboard
11A00PAC013	RD11 Modbus TCP/IP, 24 V option
11A20YAA001	Extended warranty 36 months
11A20YAA002	Extended warranty 48 months
11A20YAA003	Extended warranty 60 months

Wiring diagram – RD11 control cables

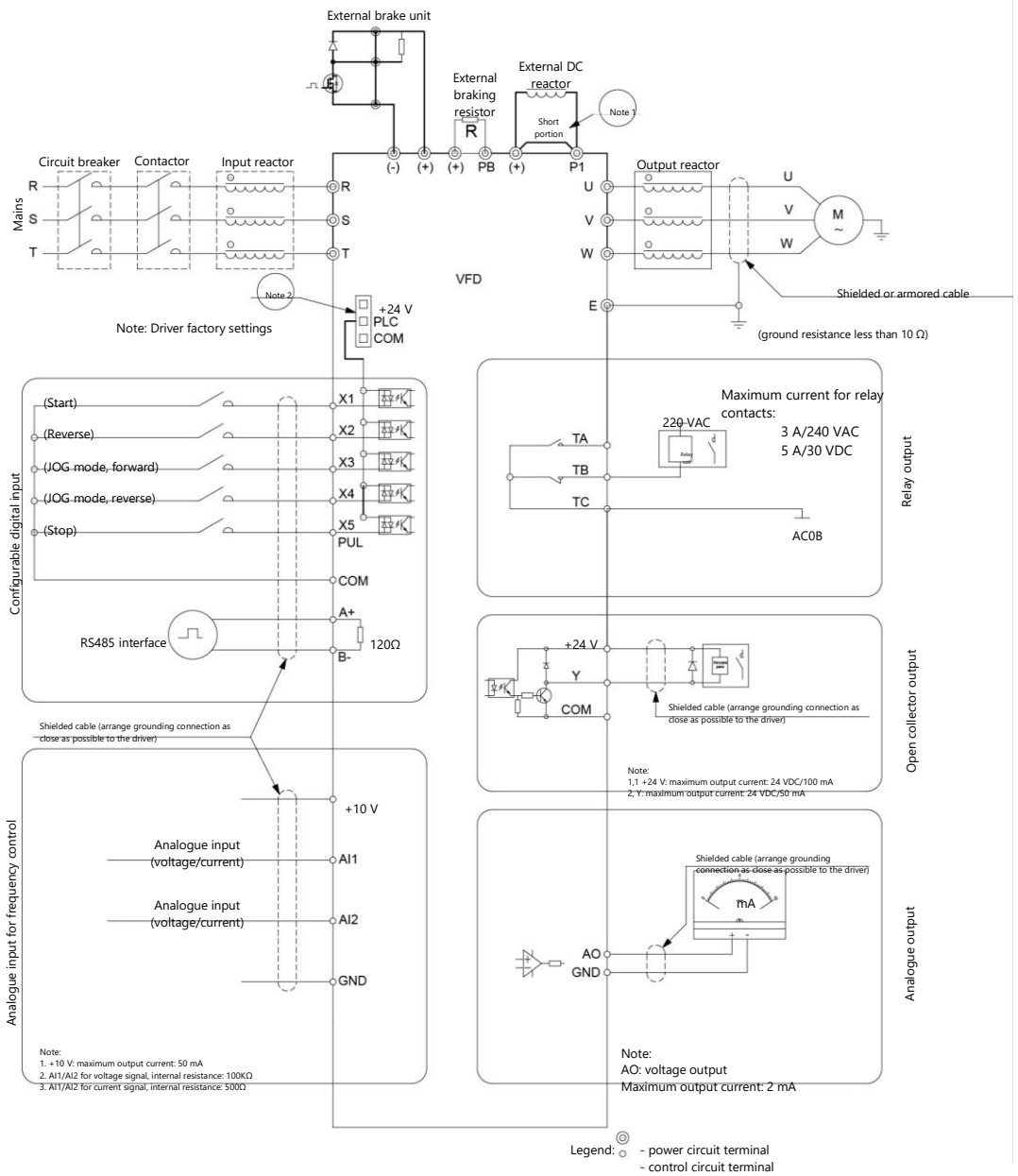

RD11 general specifications

Power input	
Input voltage	S2: 1 × 220 V
	T4: 3 × 380 V
	T6: 3 × 660 V & T9: 1140 V
Frequency	50/60 Hz ± 5 %
Deviations	Voltage unbalance < 3% Distortion level per IEC61800-2
Output (U, V, W)	
Output voltage	0–100% of input voltage under normal conditions error < 5%)
Output frequency	0–299 Hz ± 0,5 %
Overload capacity	Normal: 120 % — 35 s, 140 % — 9 s, 150 % — 3 s. High: 150 % — 89 s, 180 % — 10 s, 200 % — 3 s
Basic control parameters	
Motor type	Asynchronous, permanent magnet synchronous motor (PMSM)
Motor control mode	U/f, closed/open loop vector control
Modulation type	Space vector pulse width modulation (SVPWM)
PWM frequency	1–16 kHz
Speed control range	Open loop vector control: 1:100
	Closed loop vector control: 1:1000
Speed control accuracy in steady mode	Open loop vector control: ≤ 2 %
	Closed loop vector control: < 0.05 %
Starting torque	Open loop vector control: 150 % of 0.5 Hz
	Closed loop vector control: 200 % of 0 Hz
Response to torque changes	Open loop vector control: < 20 ms
	Closed loop vector control: < 10 ms
Frequency control accuracy	Digital input: ±0.01% of maximum frequency
	Analog input: ±0.2% of maximum frequency
Frequency control increment	Digital input: 0.01 Hz
	Analog input: ±0.05% of maximum frequency
Key Functions	
Torque compensation	Auto mode: up to 100%.
	Manual mode: up to 30%
U/f curve	Four types: linear curve, self-adapting curve, torque reduction curve (second control zone from 1.1 to 2.0 power), quadratic curve
Acceleration and deceleration curves	Two types: linear curve, S-shaped acceleration and deceleration curves.
	Four sets for acceleration and deceleration time: time step 0.01 s, maximum – 650 s
Rated output voltage	Selectable between 50 and 100% of input voltage. With supply voltage compensation function: 100%
Automatic voltage regulation	Automatic output voltage regulation for supply voltage fluctuations
Auto energy saving function	Automatic current limiting to prevent failures due to overcurrent
Standard functions	PID control, speed tracking and auto-start after power failure, jump frequencies, upper and lower frequency limits, preset speeds, RS-485, analog output, pulse frequency output
Analogue input	2 (0–10 V or 0/4–20 mA)
Relay	1
Analogue output	1 (0–10 V, 0/4–20 mA), pulse
Digital I/O	5 inputs, 1 output
Communications	Modbus RTU built-in
	Profibus (option)
	Profinet (option)
	CANopen (option)
Unshielded cable length, m	50 - up to 4 kW, 70–135 from 5.5 to 18.5 kW, 150 — 18.5 kW and higher
Display	Integrated digital
Environmental	
Maximum altitude level	1000 (for higher level, performance derating by 1% for each 100 m)
Operating temperature	–10 ... +50 °C. Derating above +40 °C
Vibration	0.6 g for range 9–200 Hz
Storage temperature	–40 ... +60 °C
Housing	IP20, IP54
Installation	Wall-mounting or panel-mounting

Notes

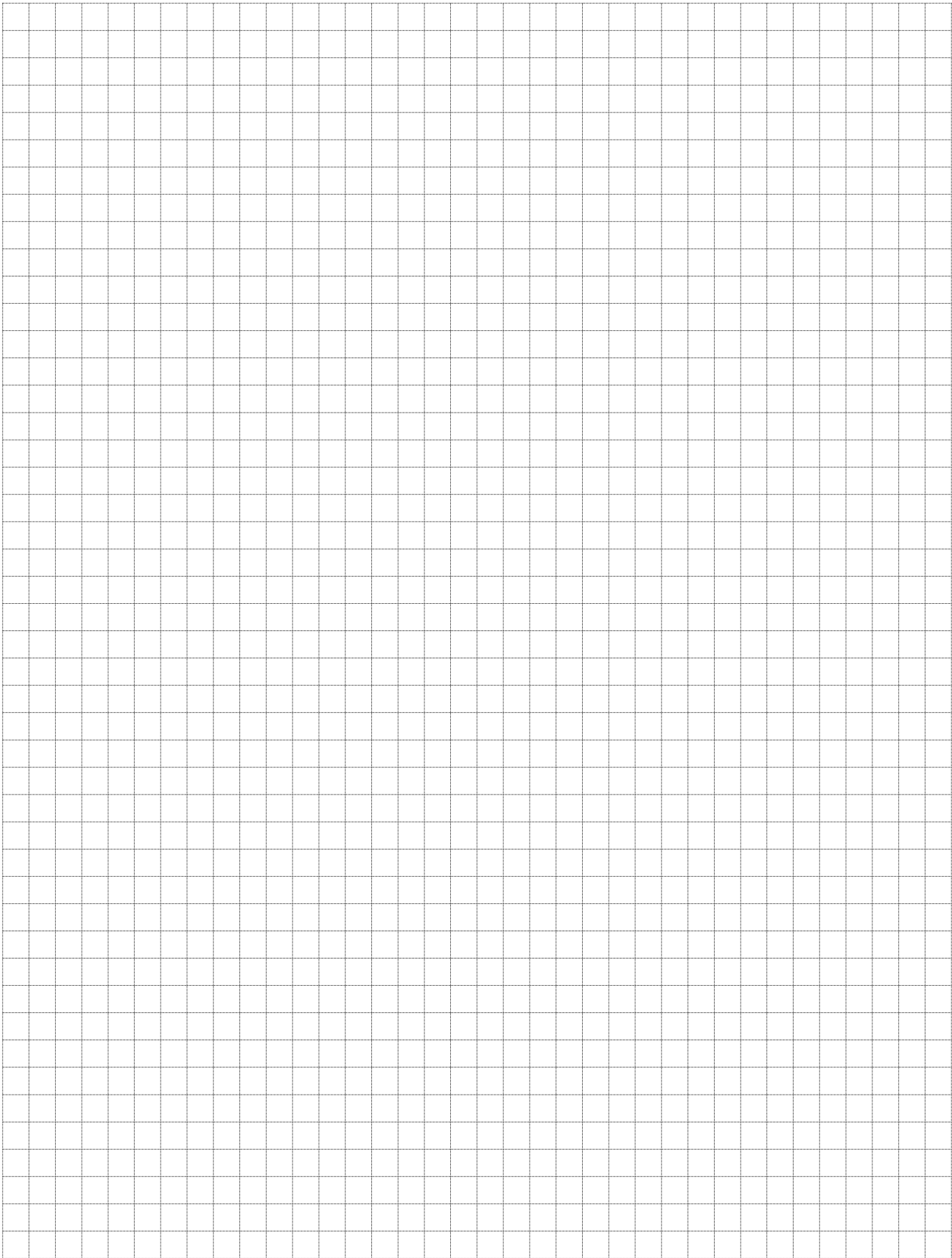

Notes

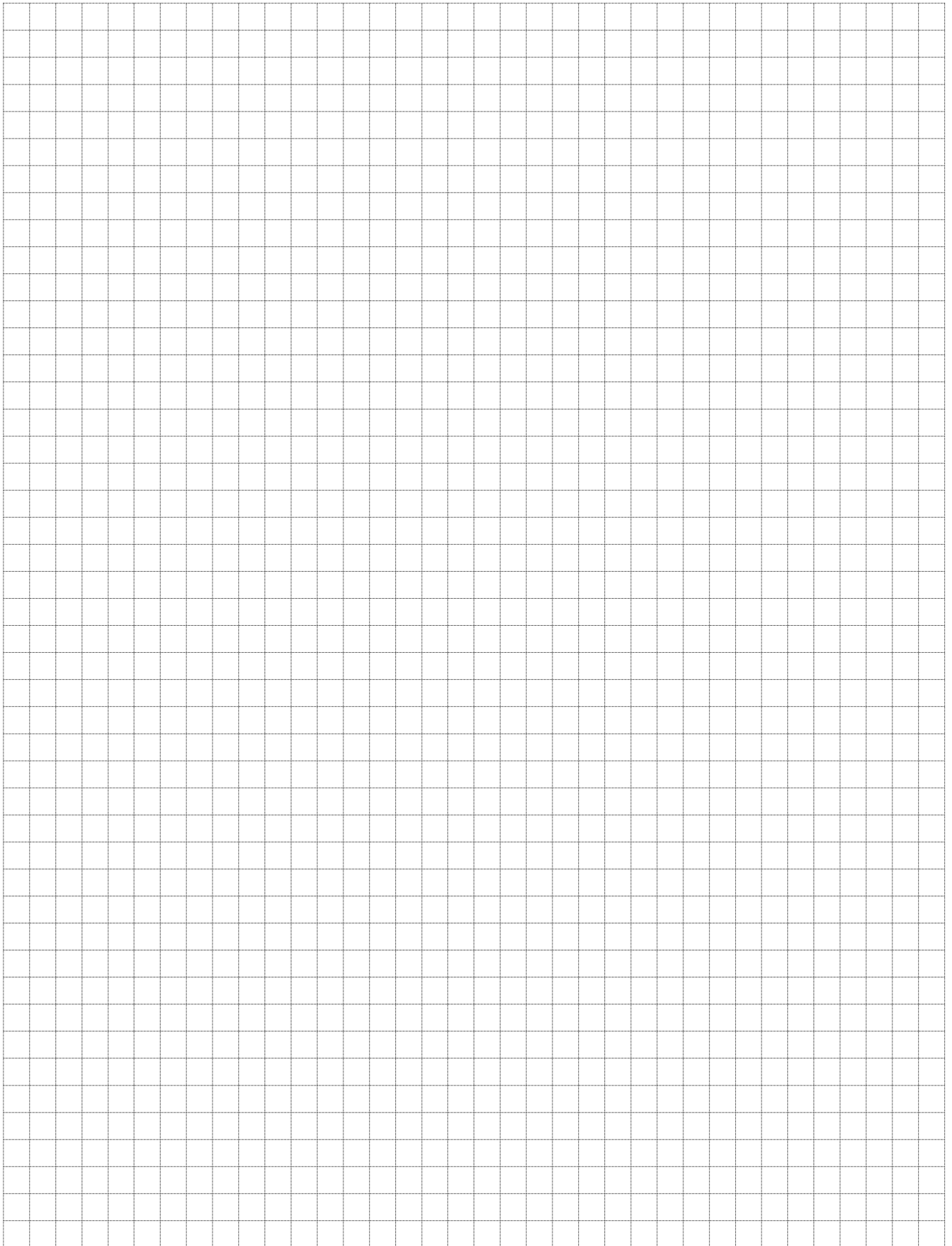

Notes

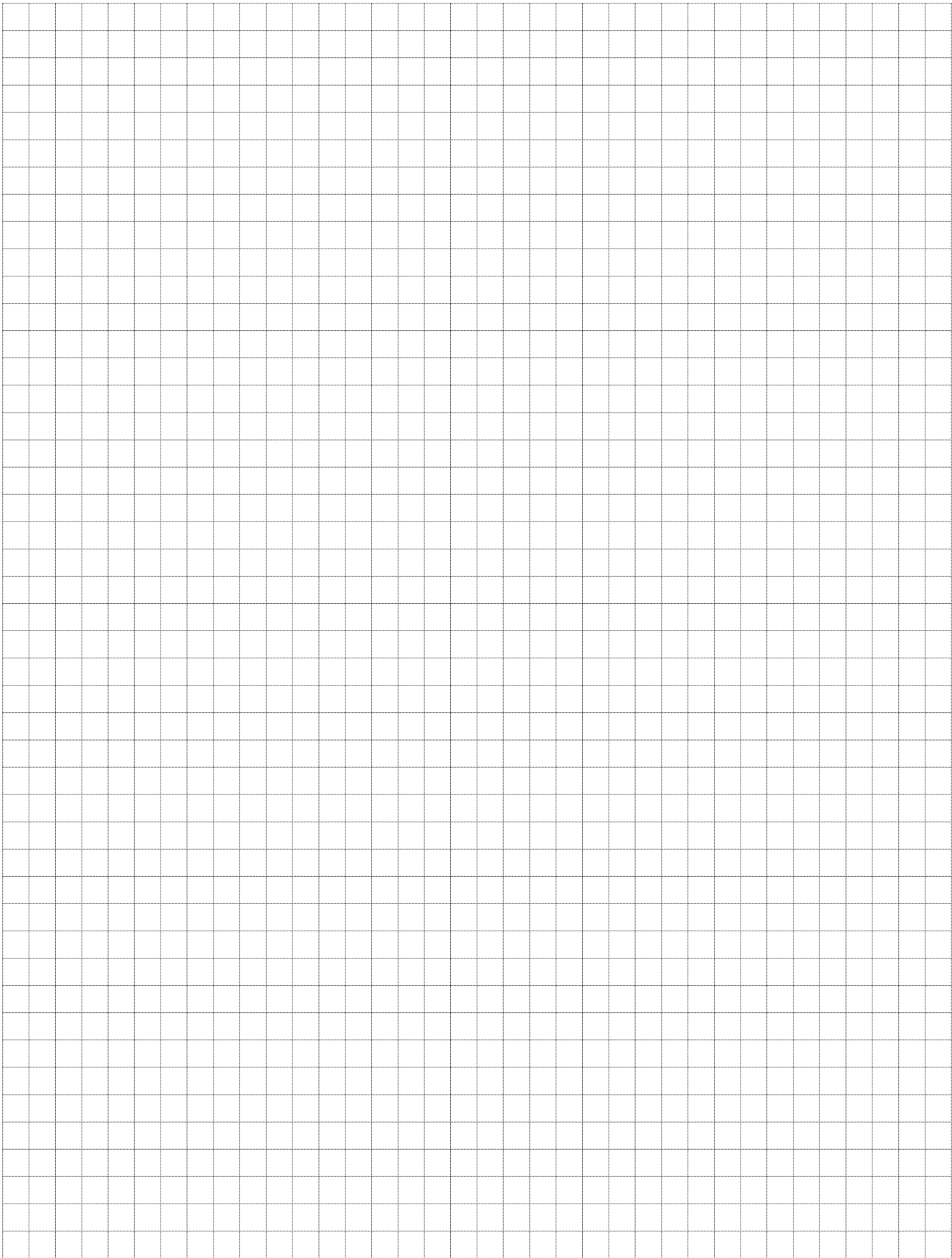

VEDA-IN DRIVES is a drive and automation technology

VEDA-IN DRIVES was founded by engineers and specialists with more than 15 years of experience in the drive technology market. The development of new products was based on the operating experience of various frequency converters, feedback from partners and customers and the technical capabilities of suppliers.

Currently, the product portfolio of VEDA-IN DRIVES includes VEDA-IN DRIVES RD low-voltage frequency converters, VEDA-IN DRIVES MVD medium-voltage converters, VEDA-IN DRIVES SFT and VEDA-IN DRIVES MV SFT soft starters, industrial logic controllers and HMI panels, servomotors, gearboxes and gearmotors, as well as all necessary options.

VEDA-IN DRIVES products are manufactured in fully automated factories under the strict supervision of VEDA-IN DRIVES specialists. We have ambitions to take our share in the market as a reliable supplier of power electronics and related products under our own brand.

VEDA-IN DRIVES product advantages

- Proprietary designs, performance flexibility.
- 100% focus on frequency converters and more than 15 years of experience.
- Shortest delivery times.
- Energy saving: up to 50 % on average in applications with pumps and fans.
- Warranty and post-warranty maintenance of equipment.

VEDA-IN DRIVES drive technology is widely used in areas such as water supply and wastewater disposal, heating, ventilation and air conditioning (HVAC), chemical and mining industries, lifts and cranes, shipbuilding, oil and gas production, power generation.

VEDA-IN DRIVES specialists regularly organize training seminars for engineering company specialists and service partners in the field of efficiency improvement and process automation. Special courses are used to train engineers for consumer companies.

